

hapTECH 11/2009

Nachhaltige Lösung von Usability Problemen durch die gezielte Gestaltung haptischer Rückinformationen

hapTECH 11/2009

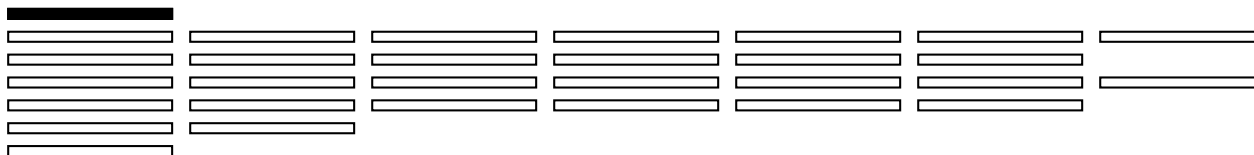



hapTECH 11/2009

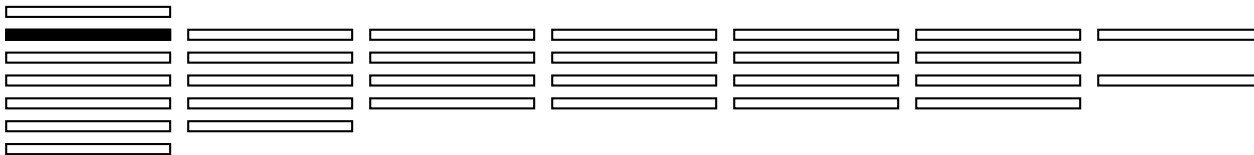

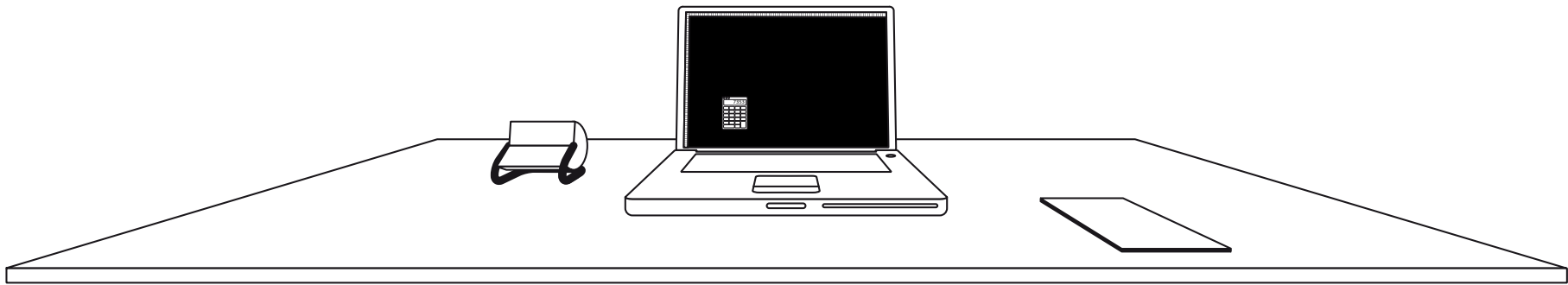

hapTECH 11/2009

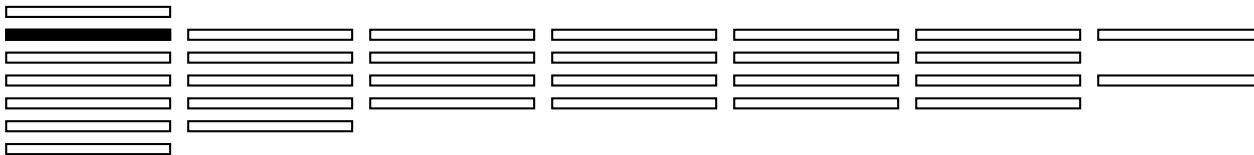



hapTECH 11/2009

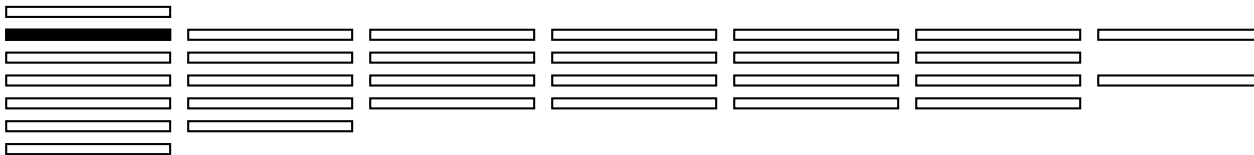



hapTECH 11/2009

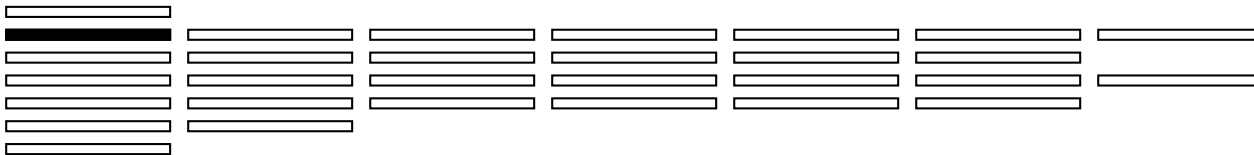

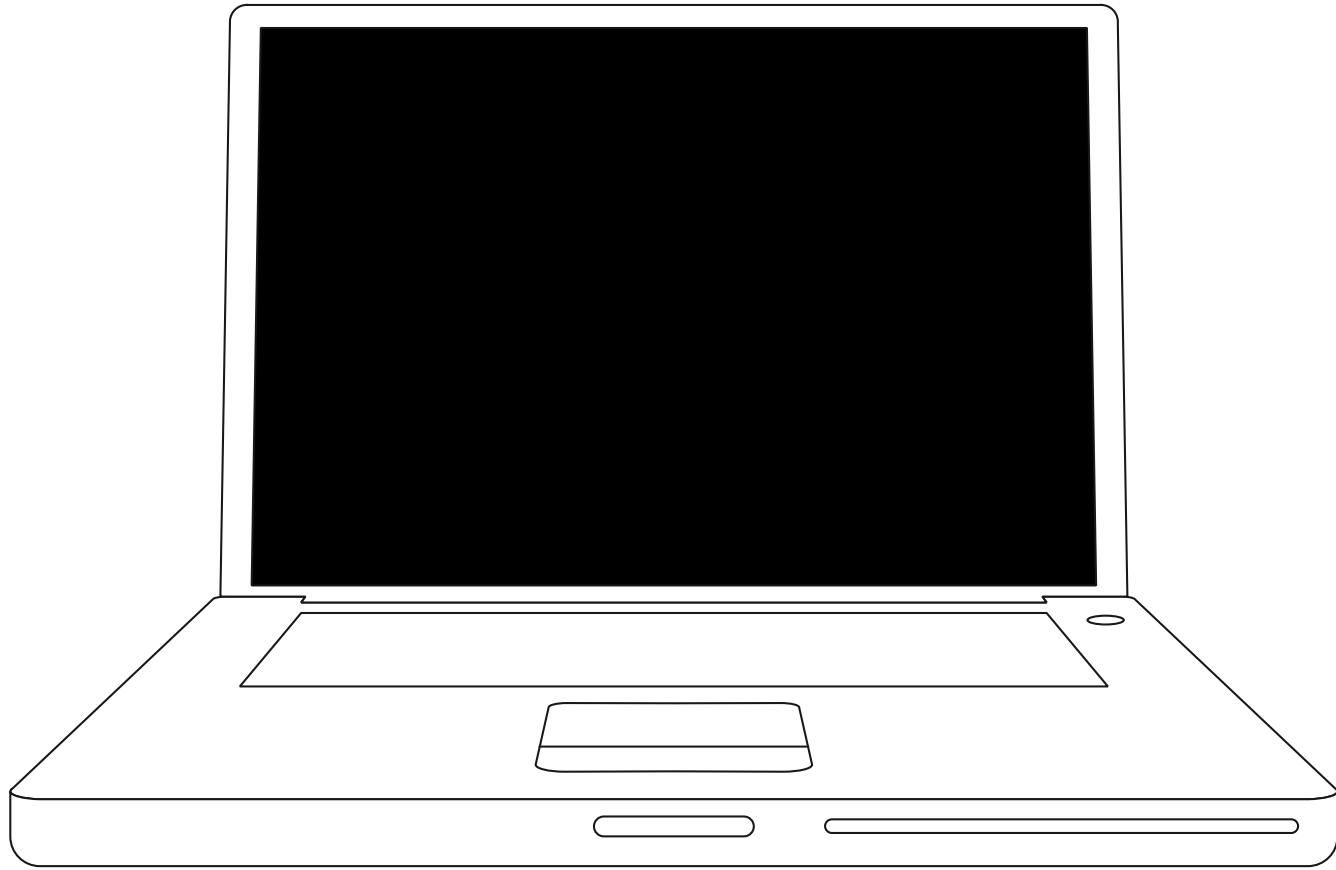

hapTECH 11/2009

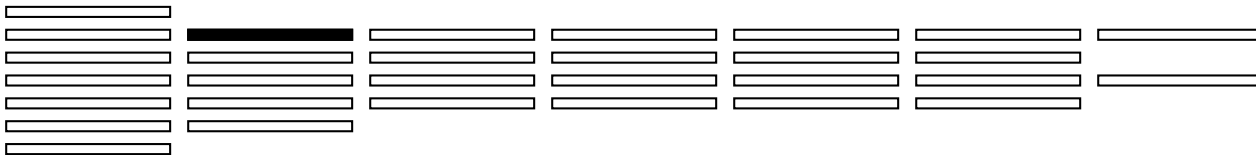

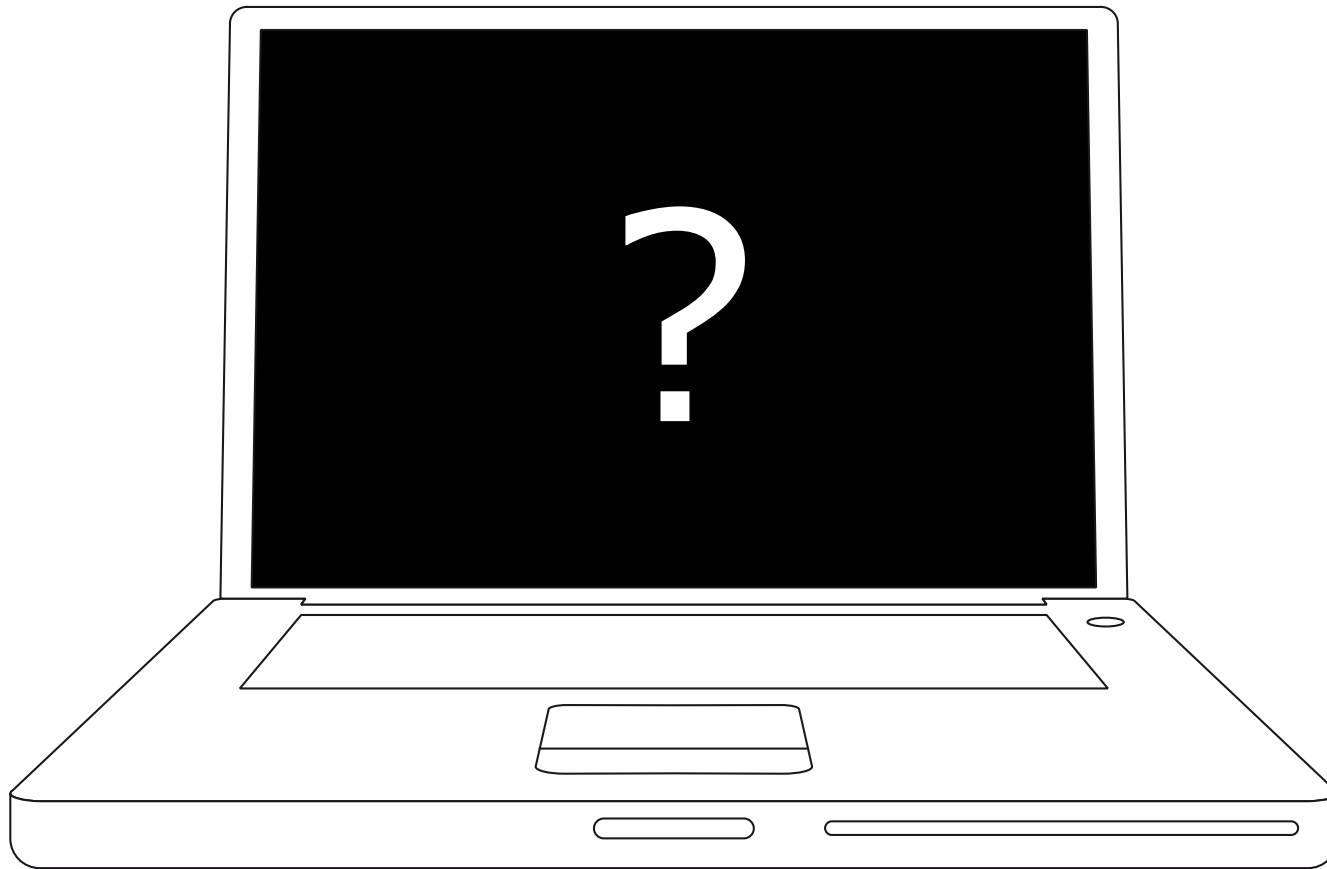

hapTECH 11/2009

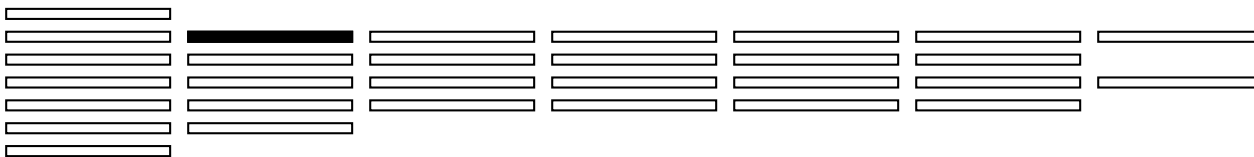

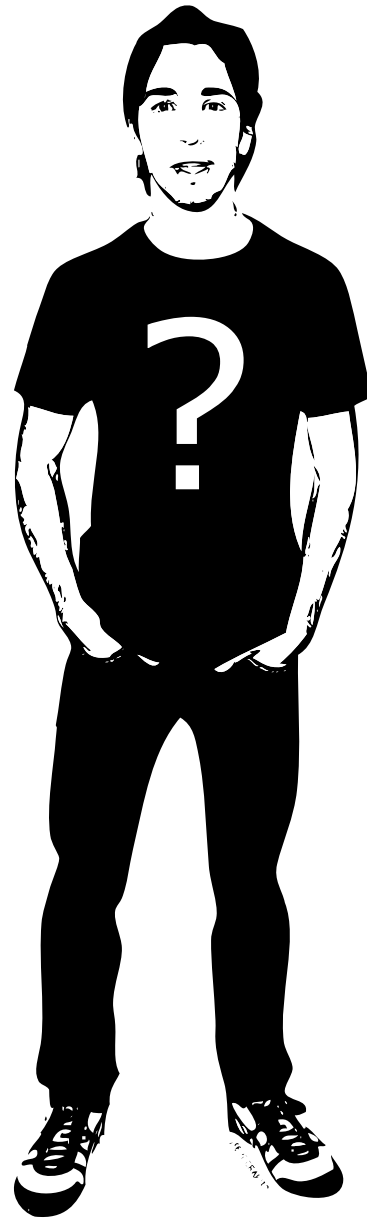

hapTECH 11/2009

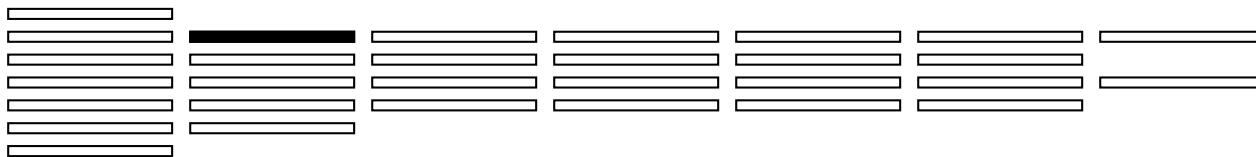

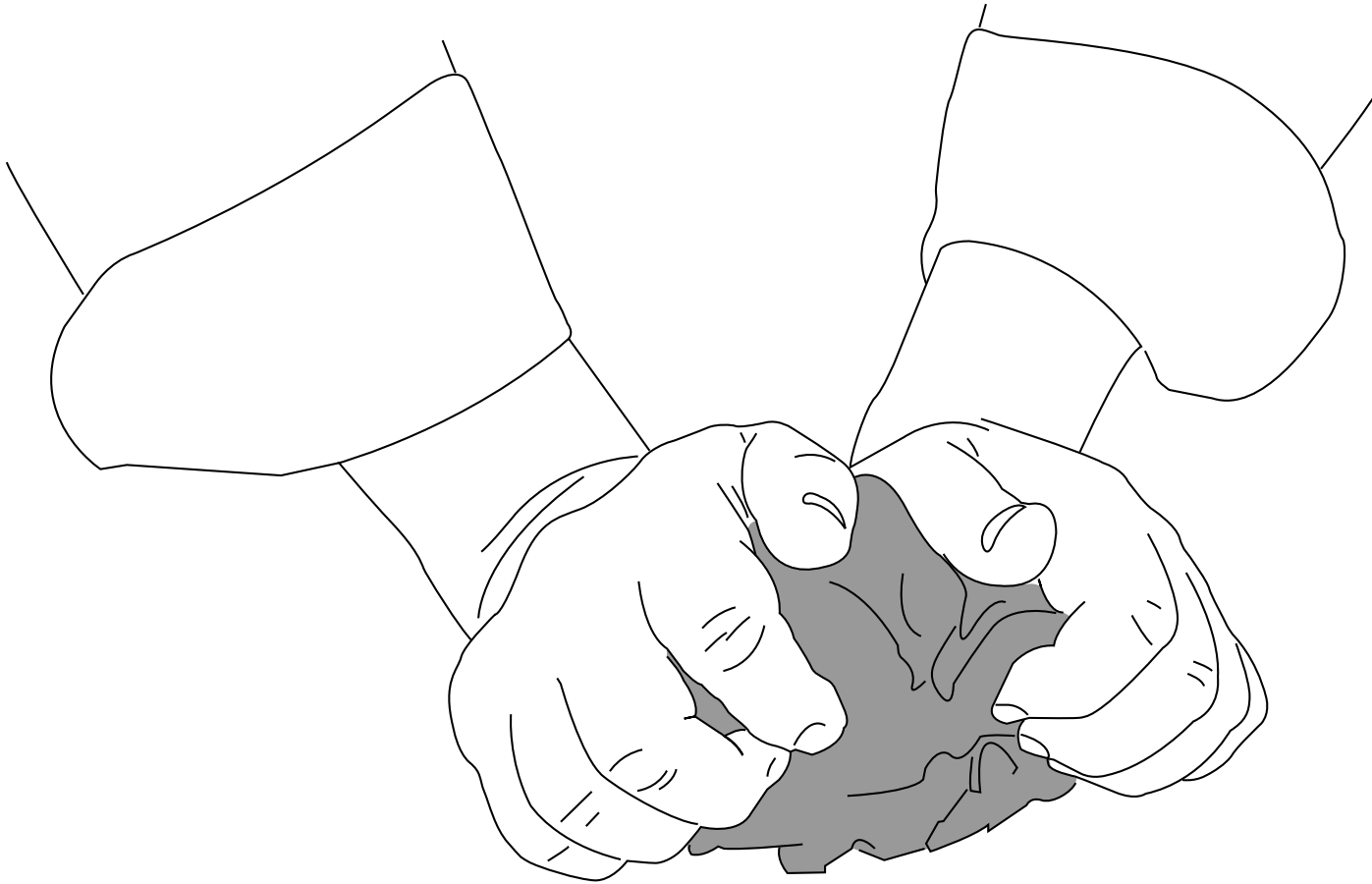

hapTECH 11/2009

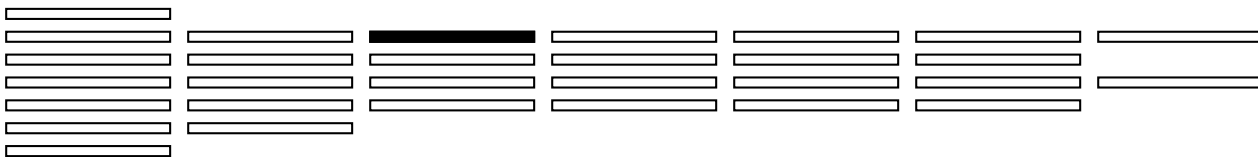

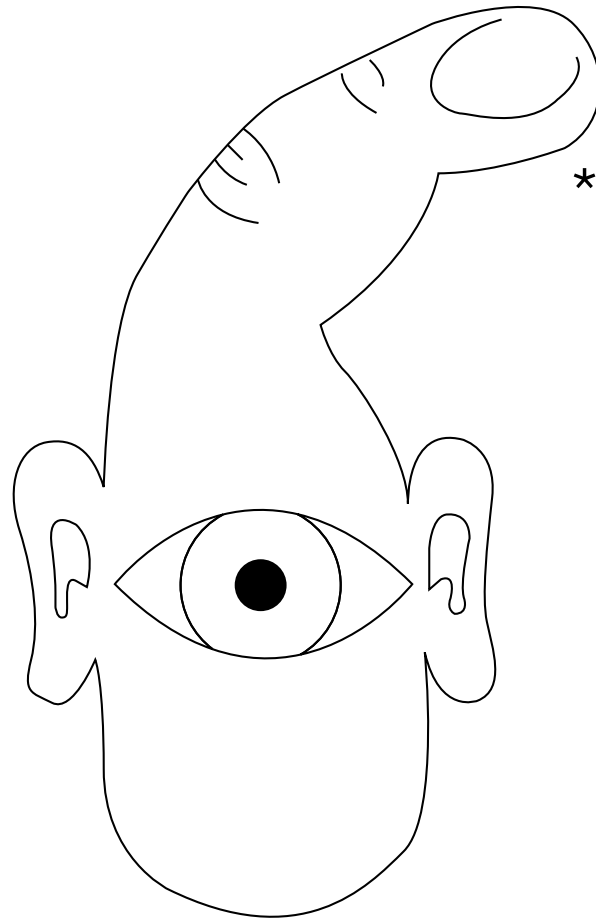

* Bruce Sterling

hapTECH 11/2009



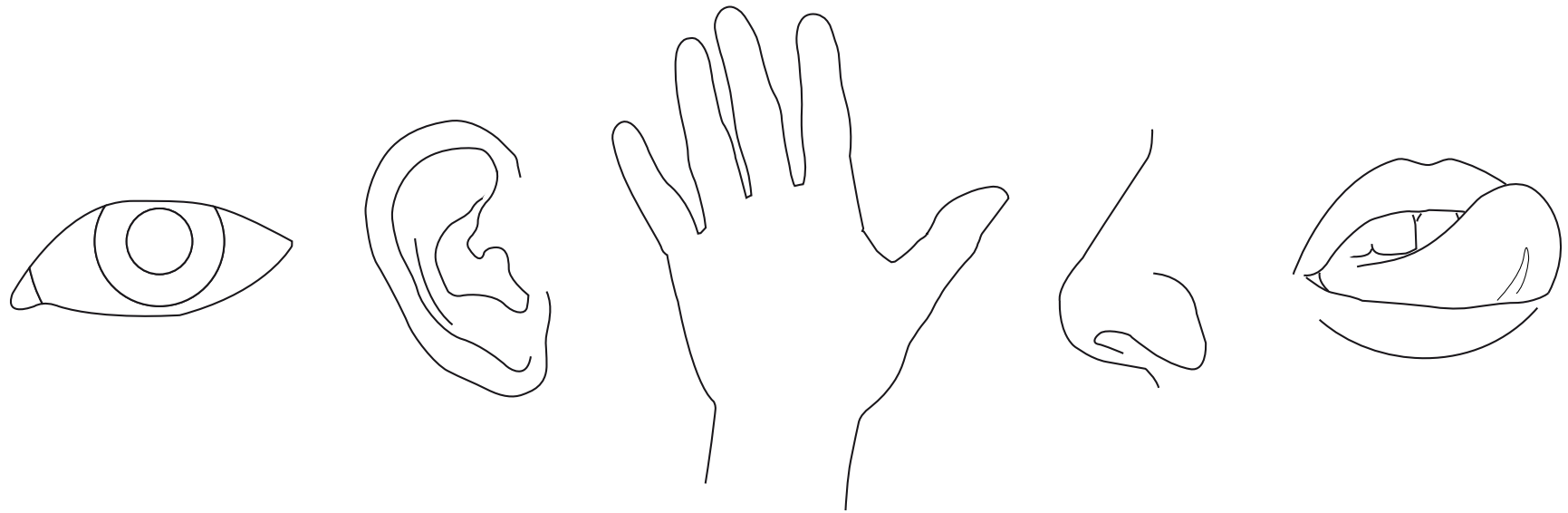

hapTECH 11/2009

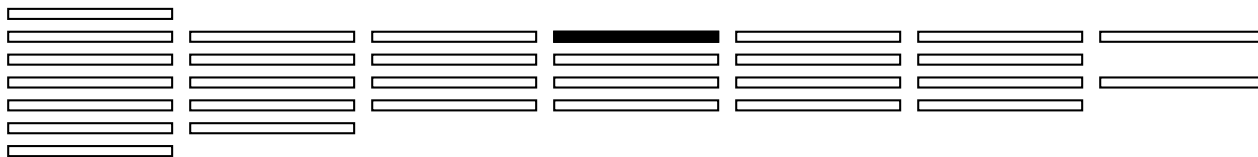

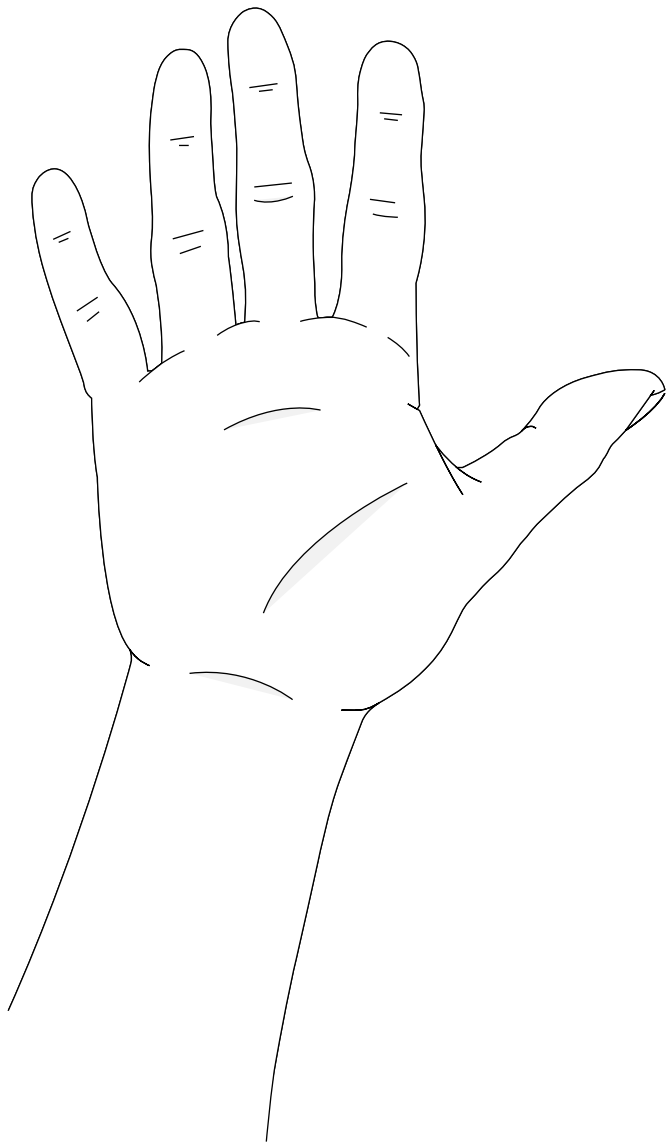

hapTECH 11/2009

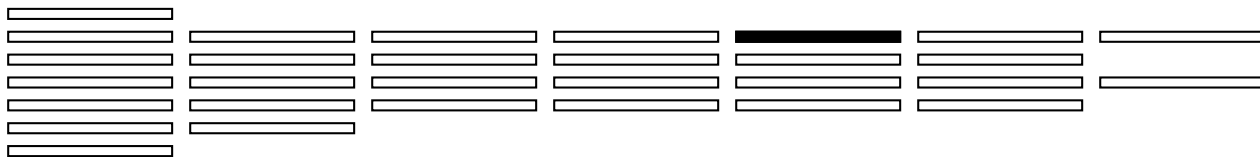



hapTECH 11/2009

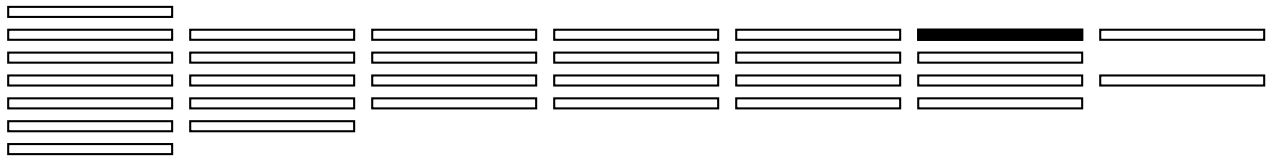

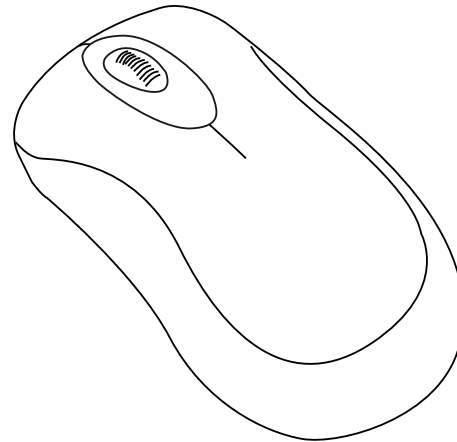
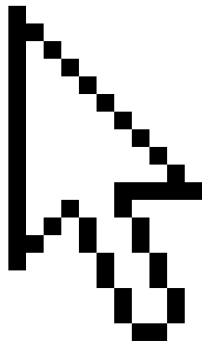

hapTECH 11/2009

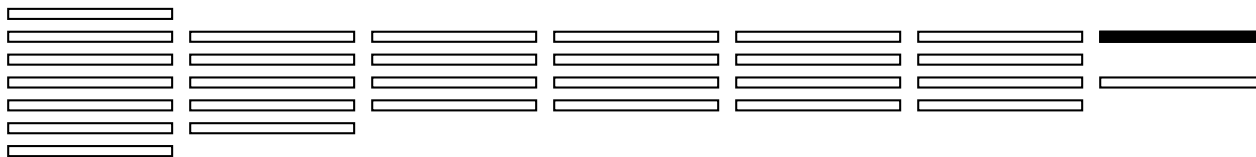

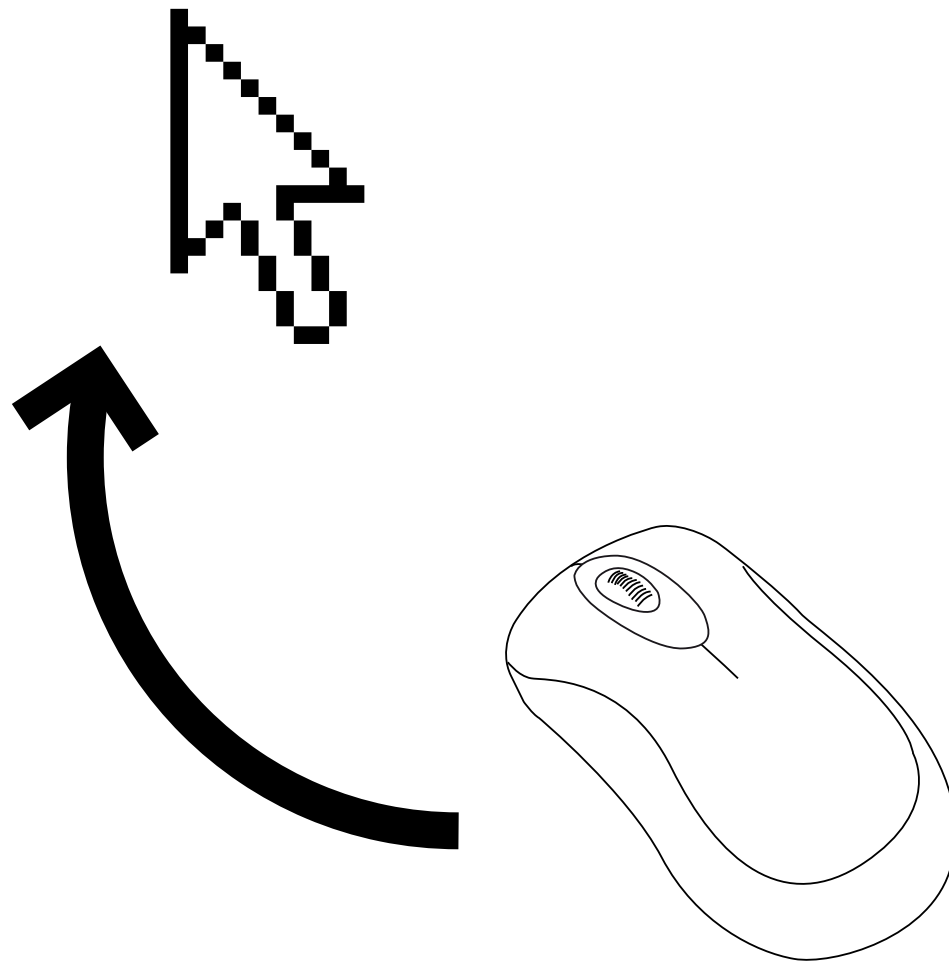

hapTECH 11/2009

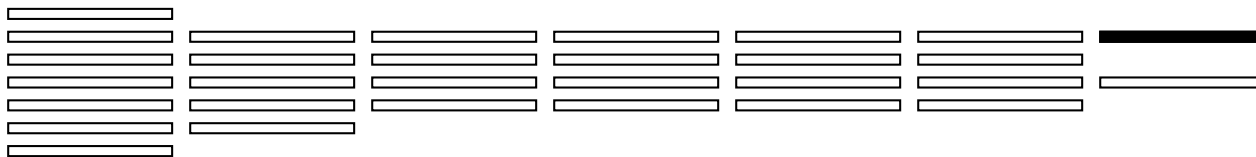

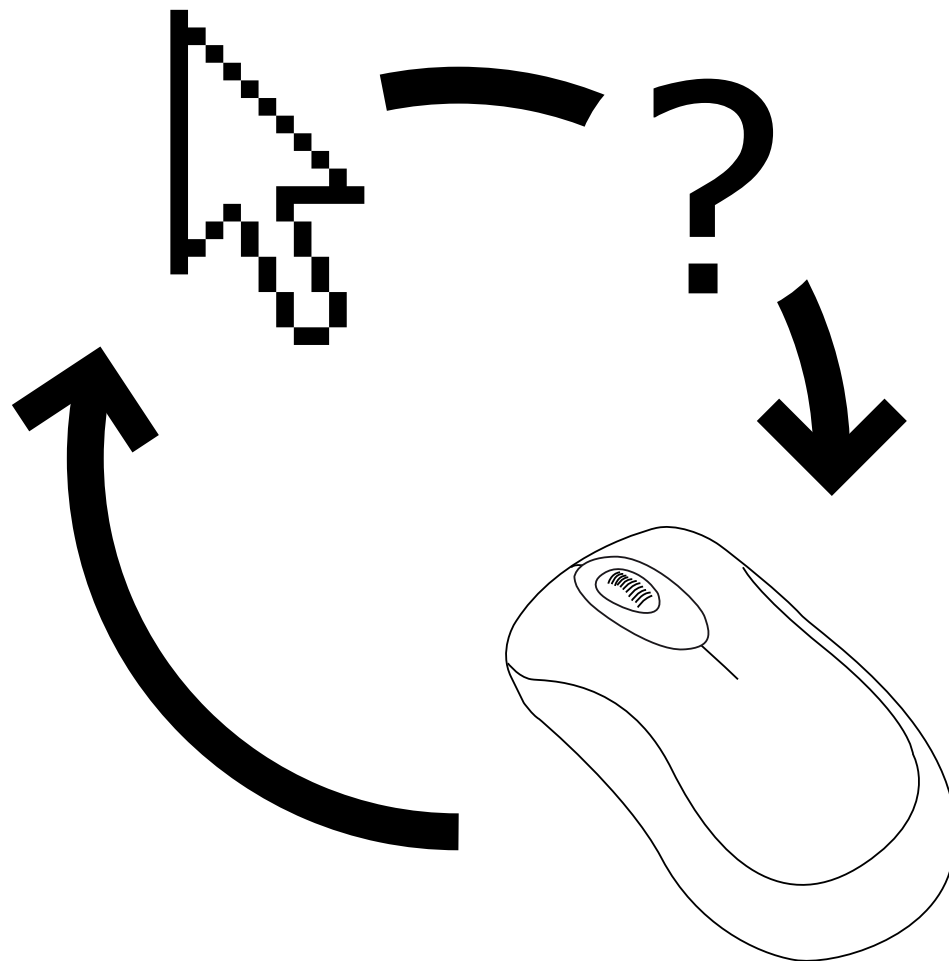

hapTECH 11/2009

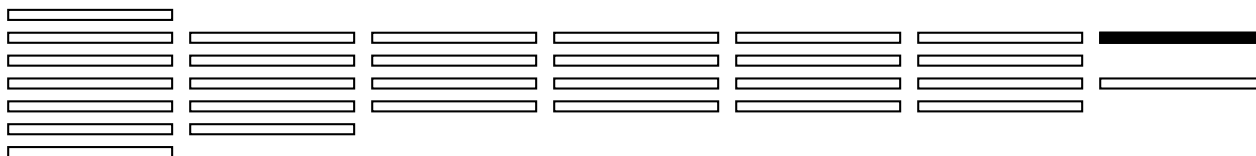

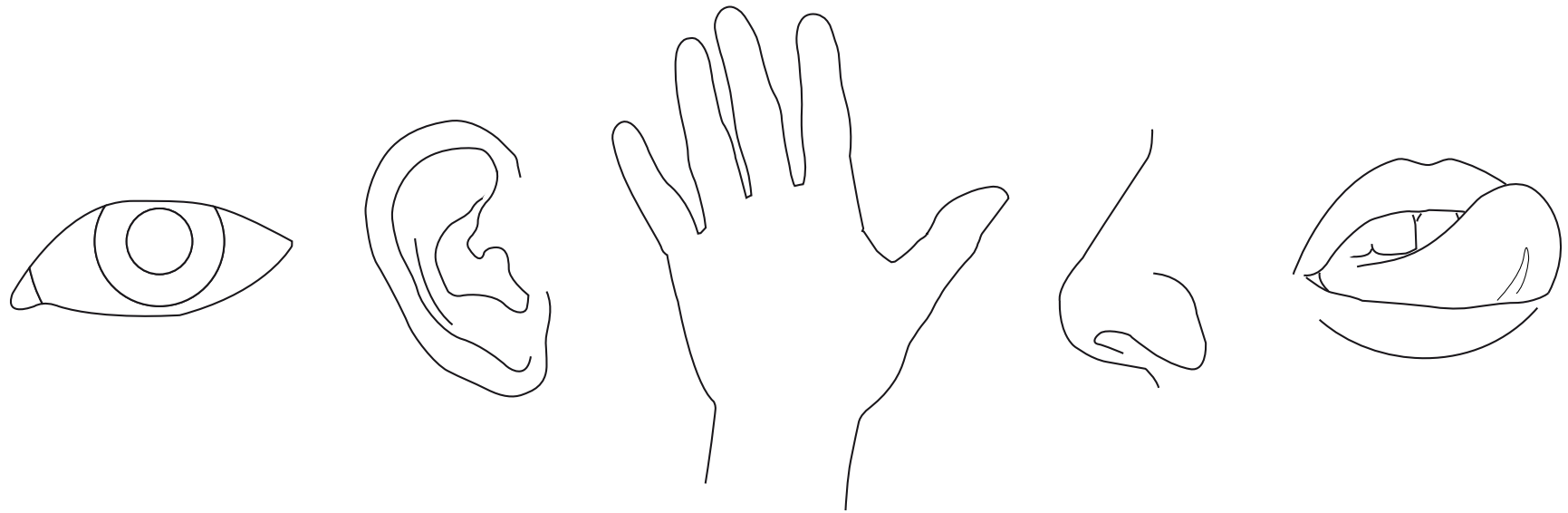

hapTECH 11/2009

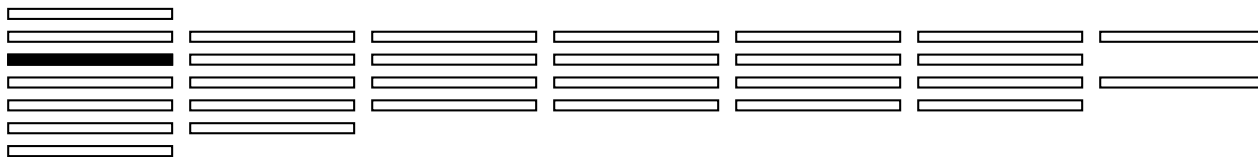

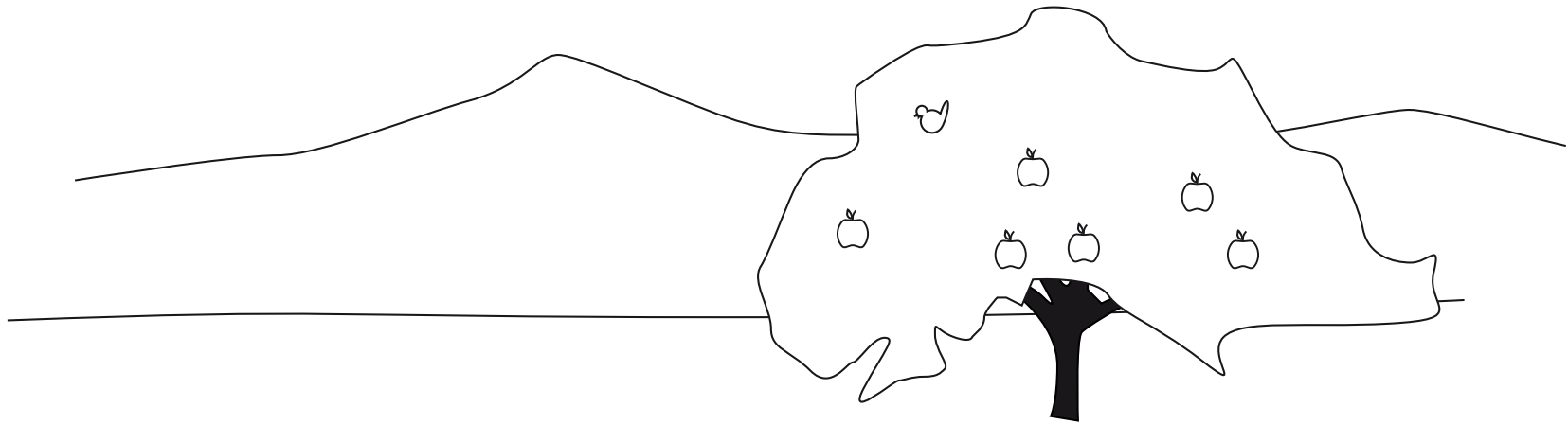

hapTECH 11/2009

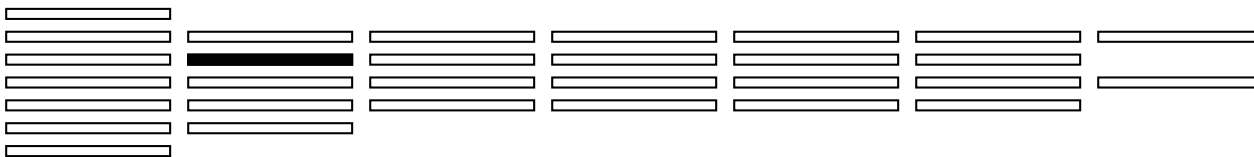

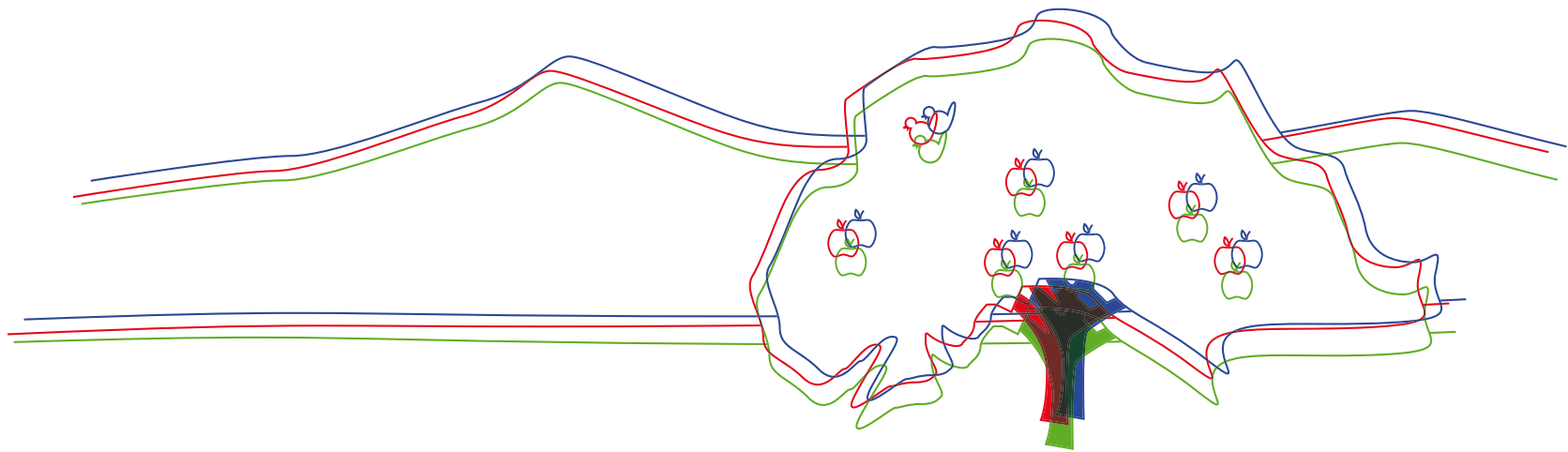

hapTECH 11/2009

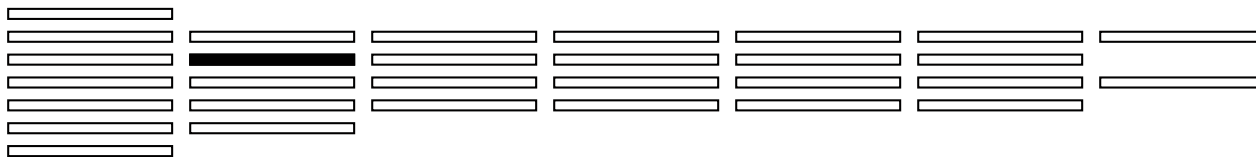

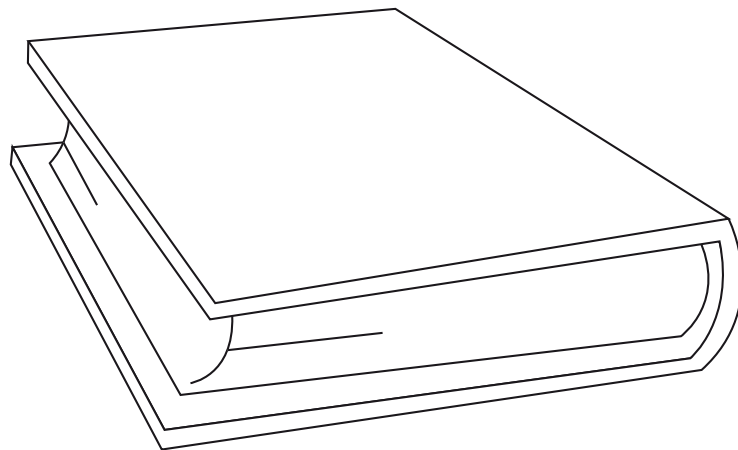

hapTECH 11/2009

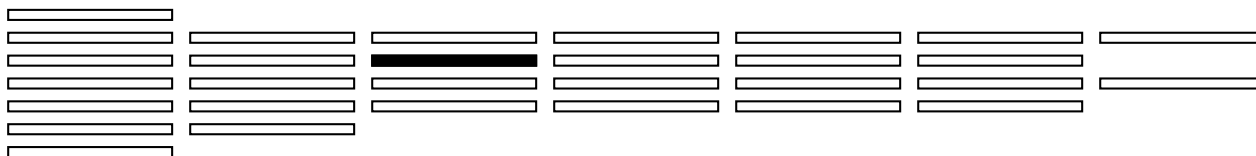

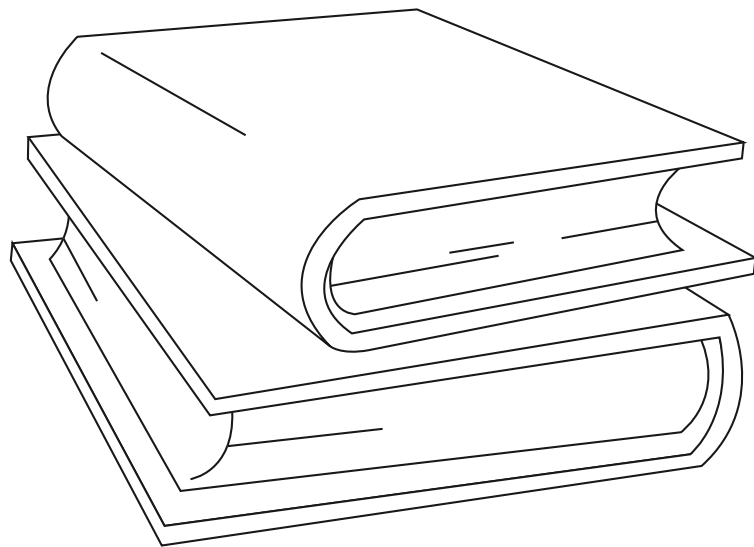

hapTECH 11/2009

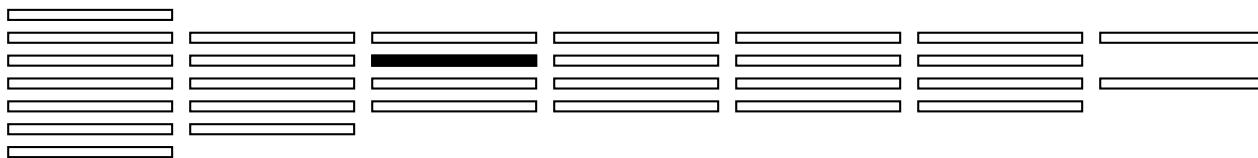

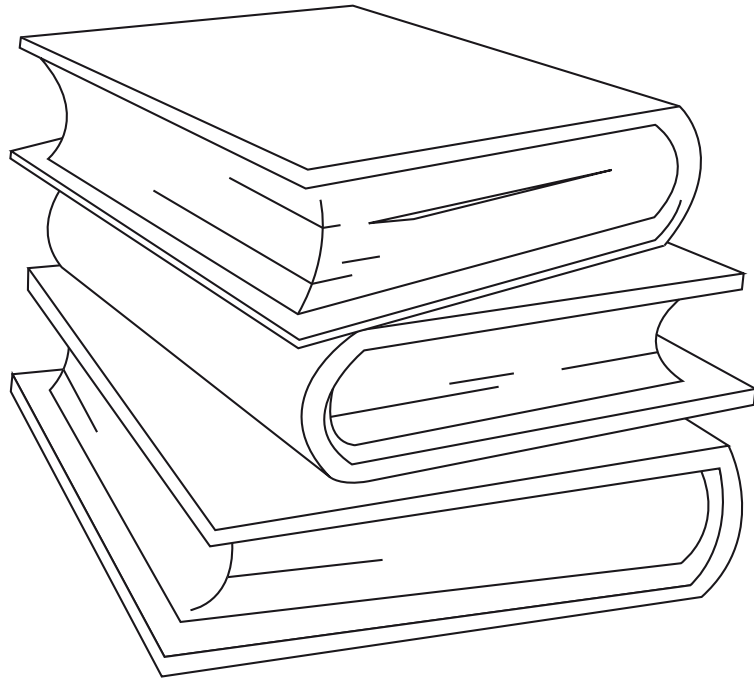

hapTECH 11/2009

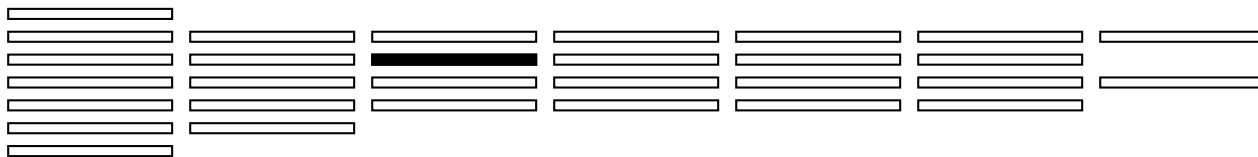

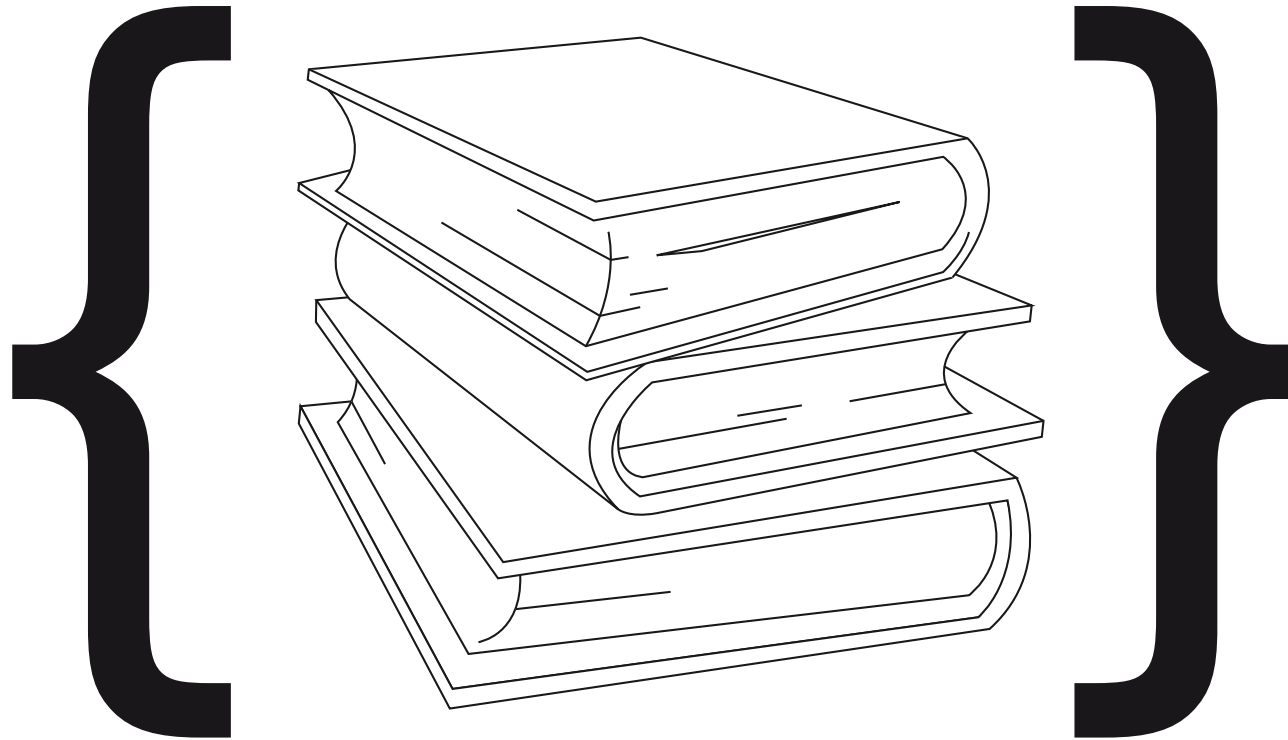

hapTECH 11/2009

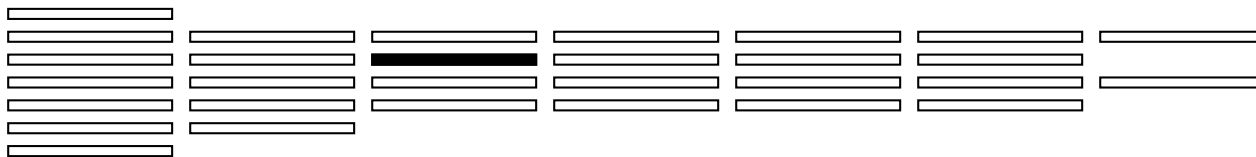

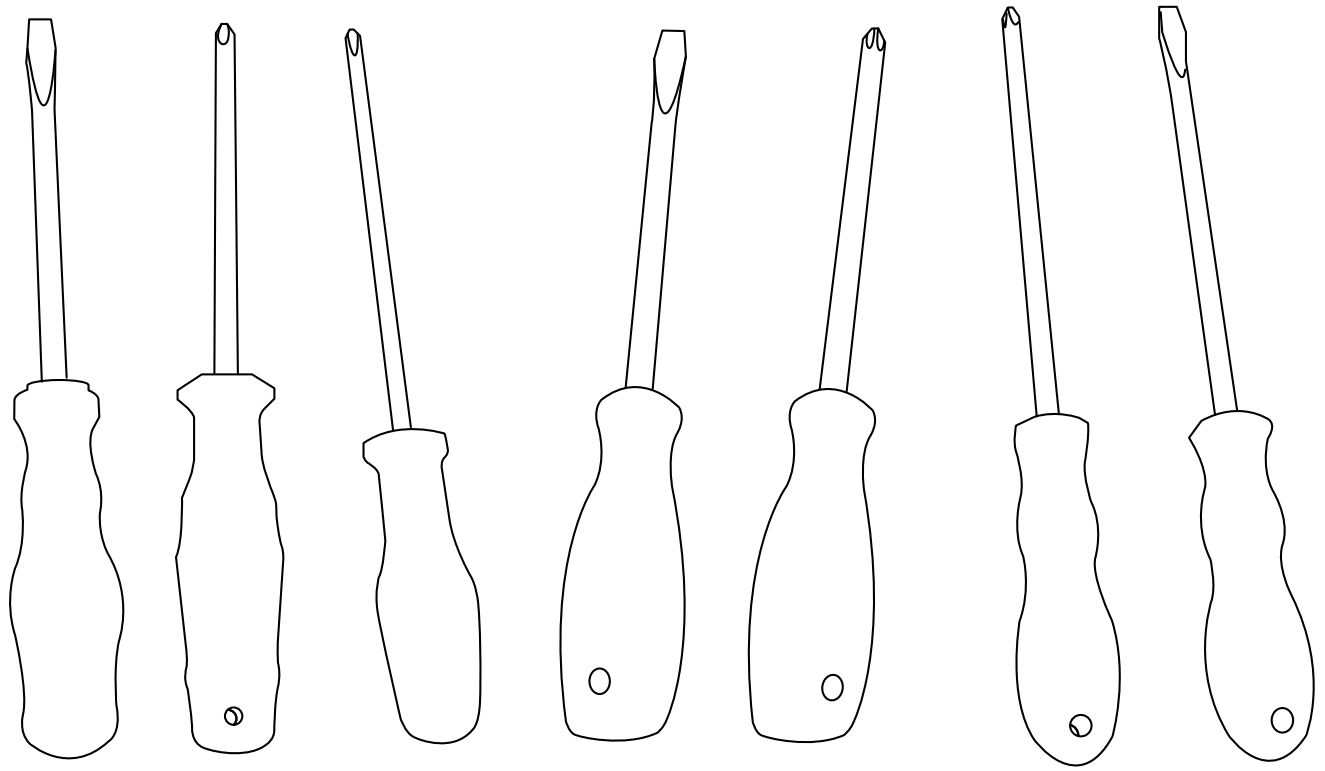

hapTECH 11/2009

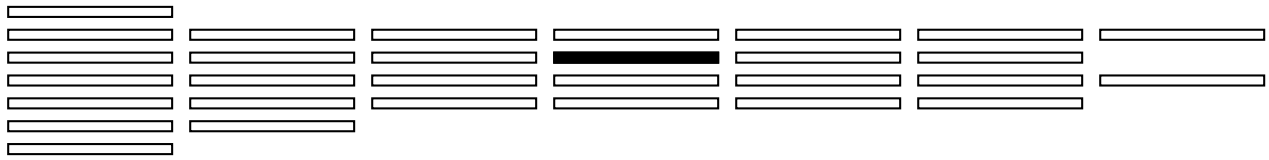

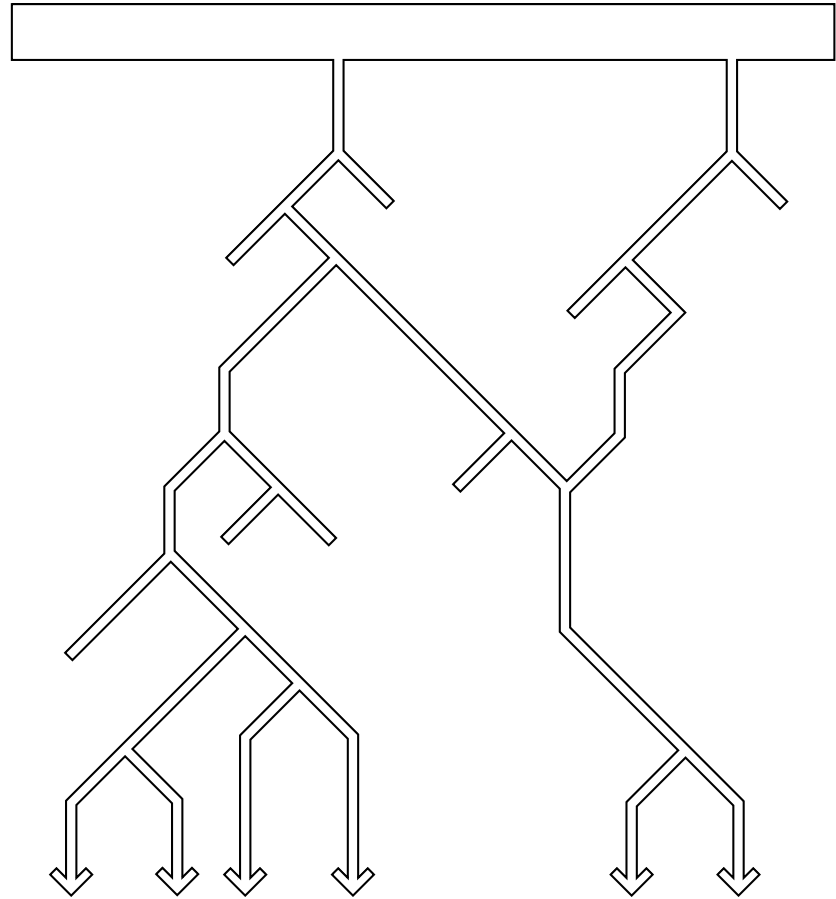
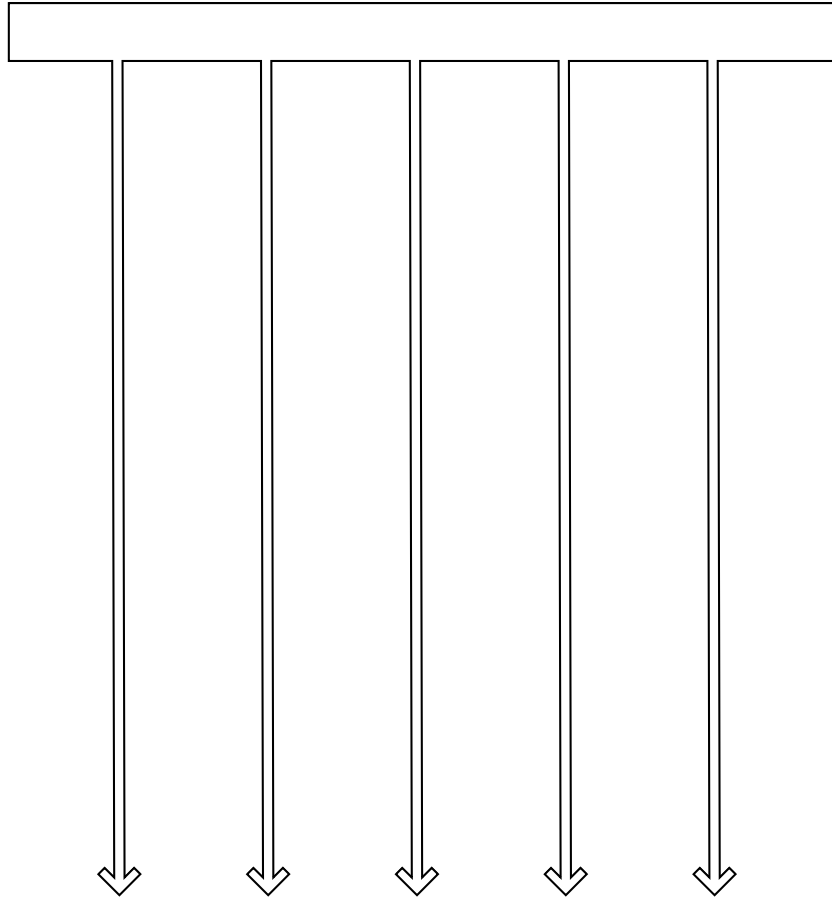

hapTECH 11/2009

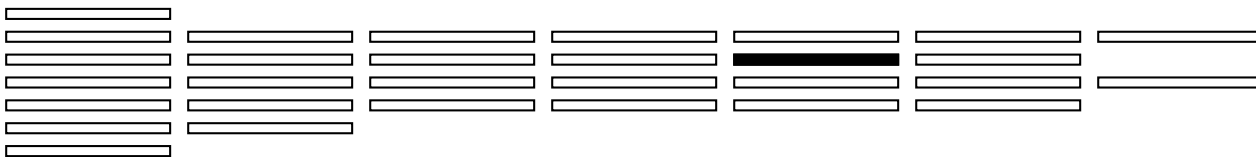



hapTECH 11/2009

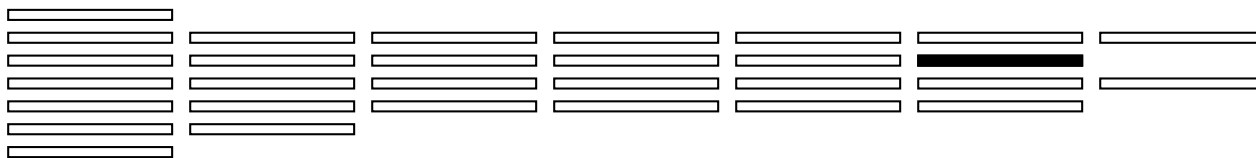



hapTECH 11/2009

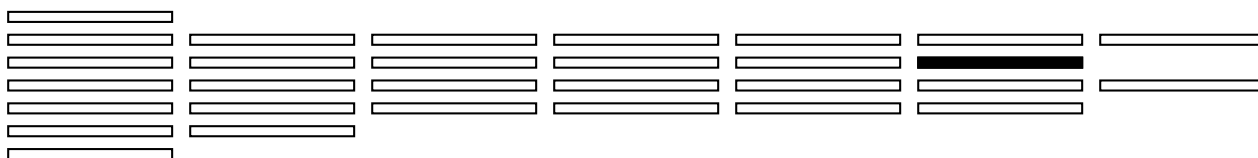



hapTECH 11/2009

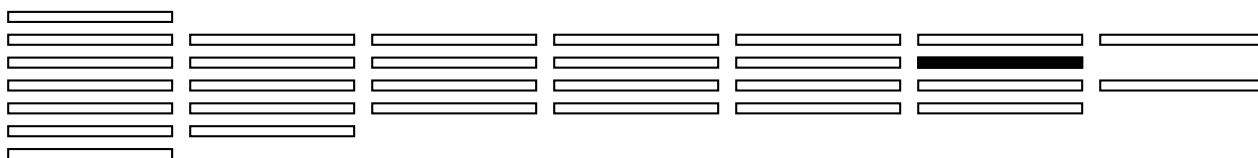

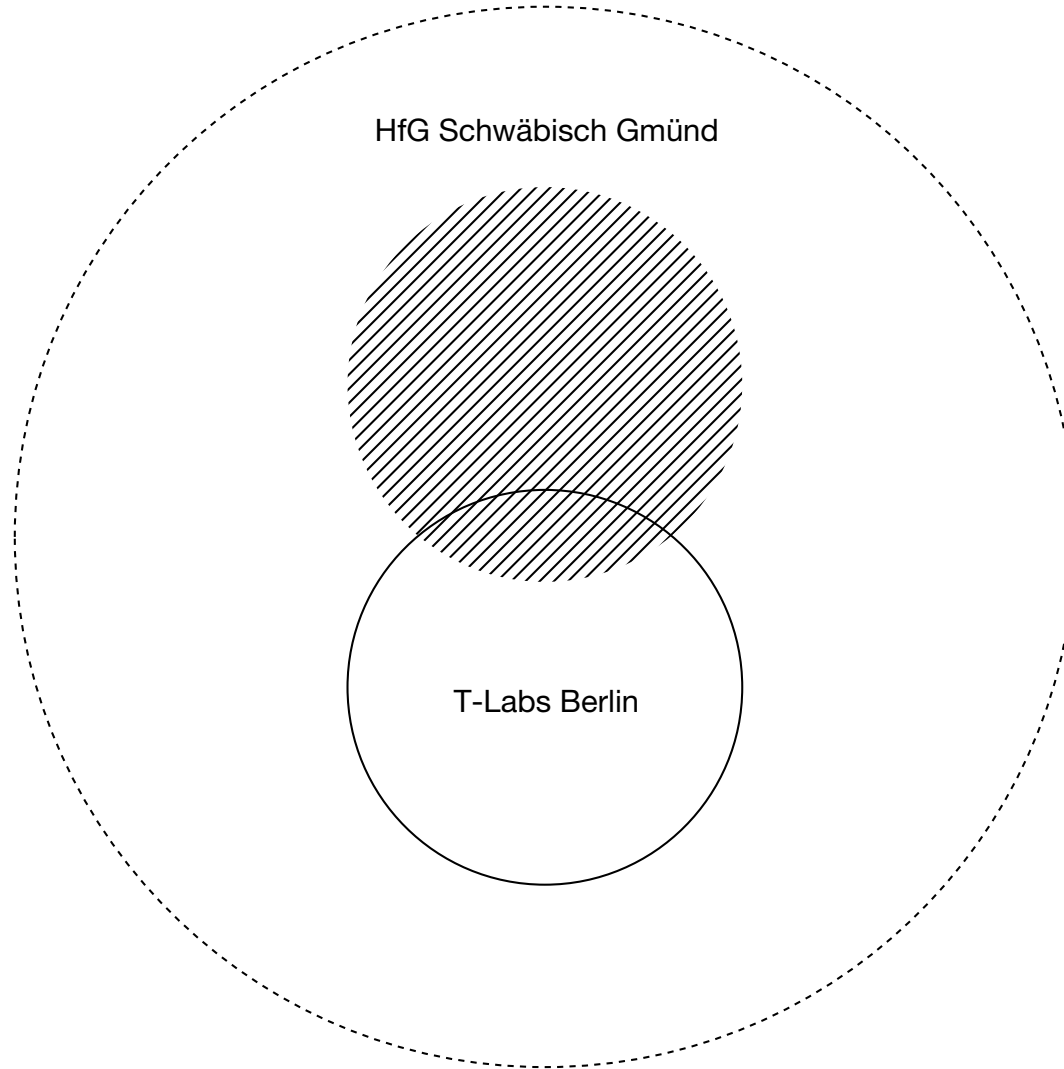

hapTECH 11/2009

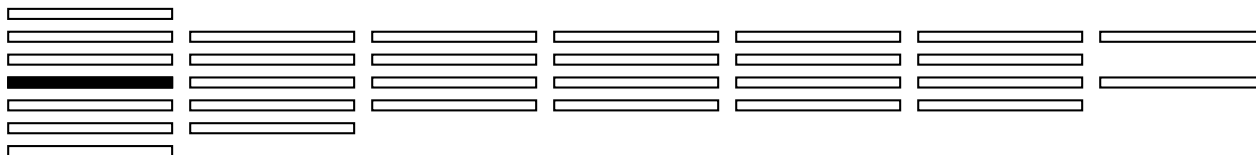

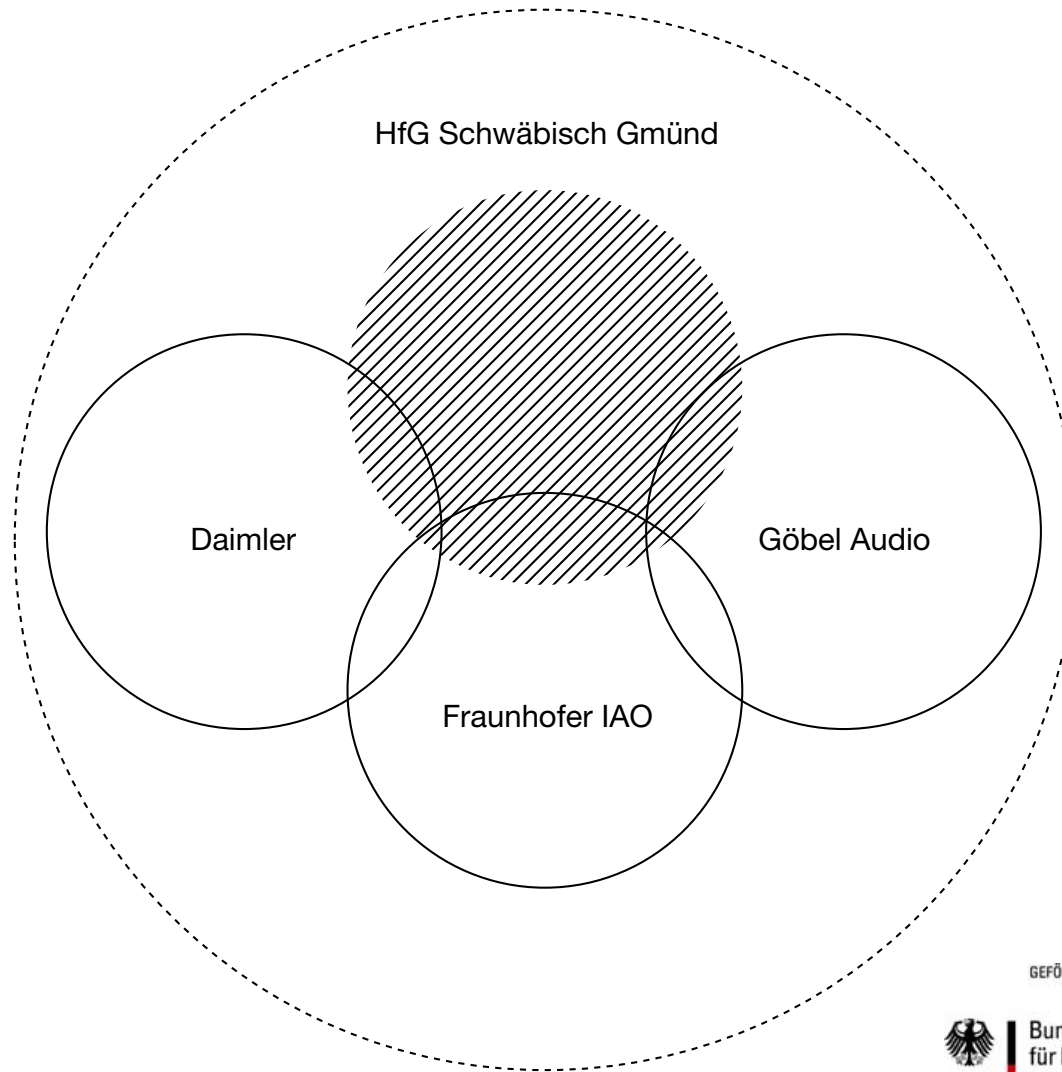

GEFÖRDERT VOM



Bundesministerium
für Bildung
und Forschung

hapTECH 11/2009

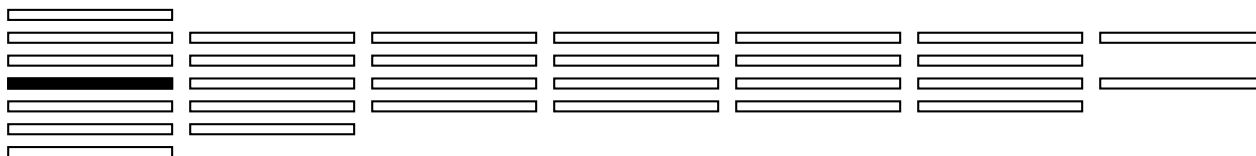

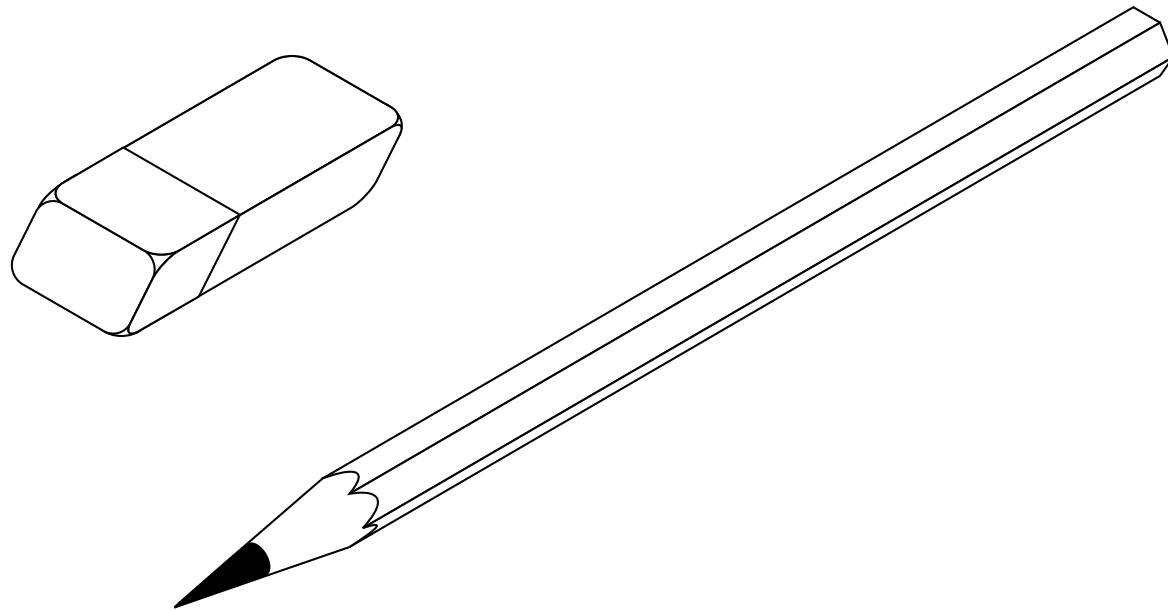

hapTECH 11/2009

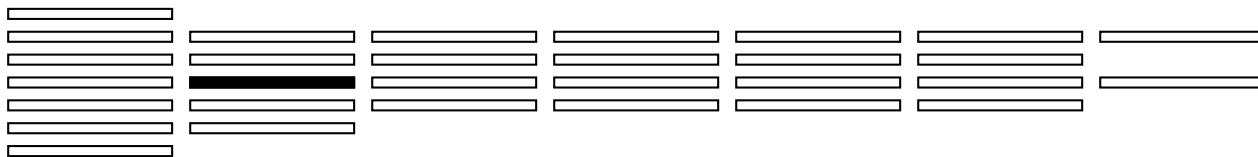

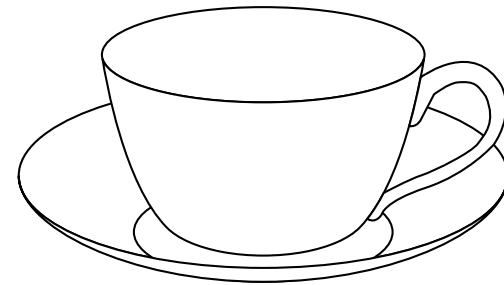
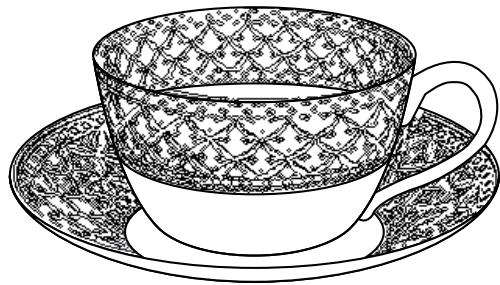

hapTECH 11/2009

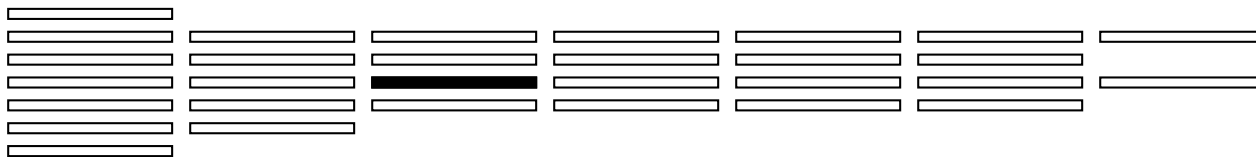

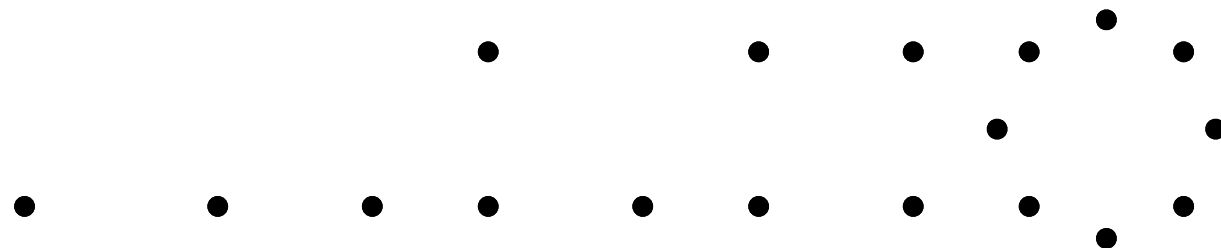

hapTECH 11/2009

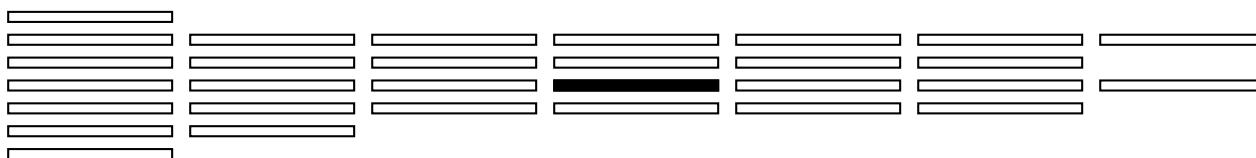

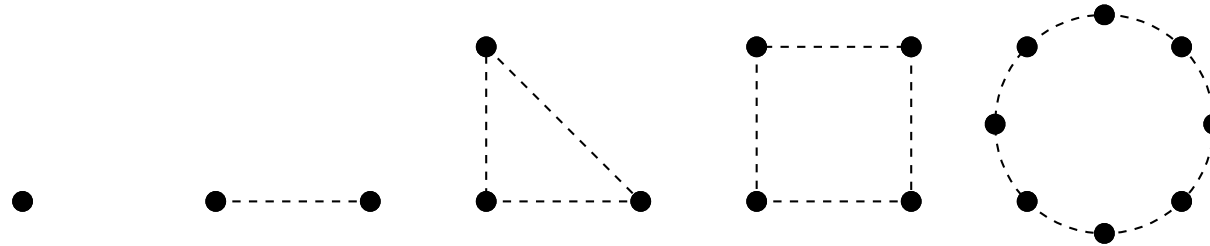

hapTECH 11/2009

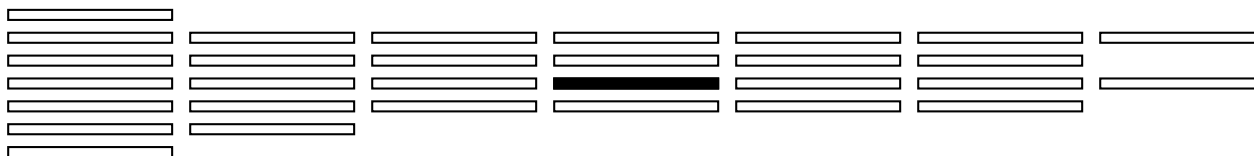

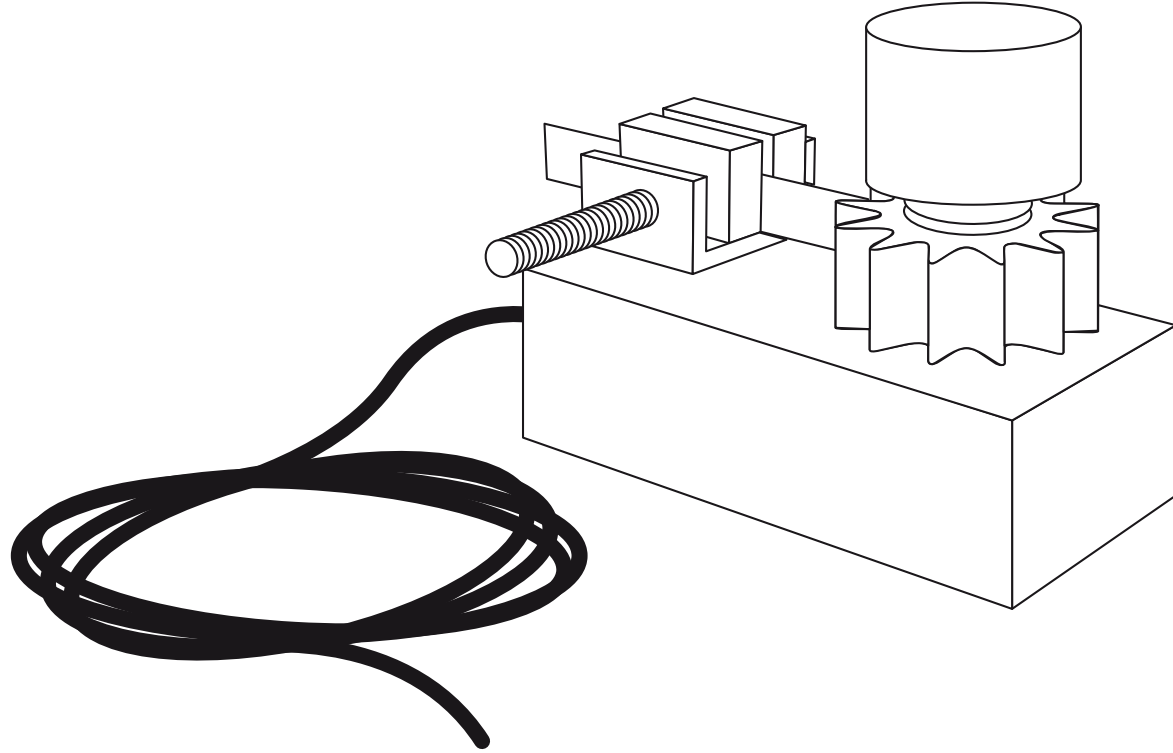

hapTECH 11/2009

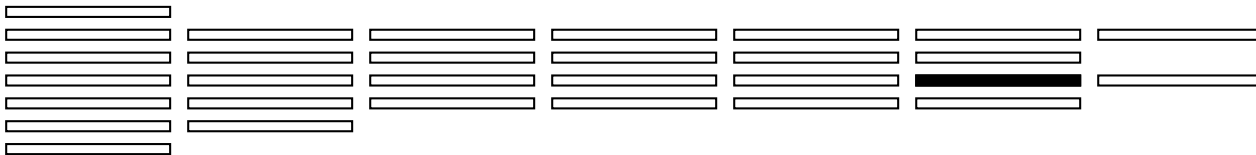

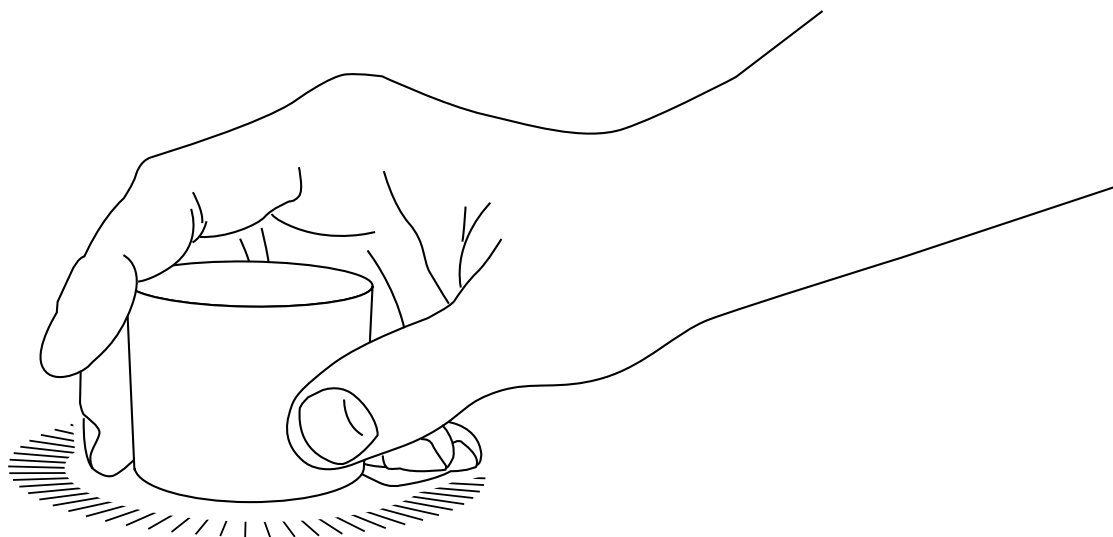

hapTECH 11/2009

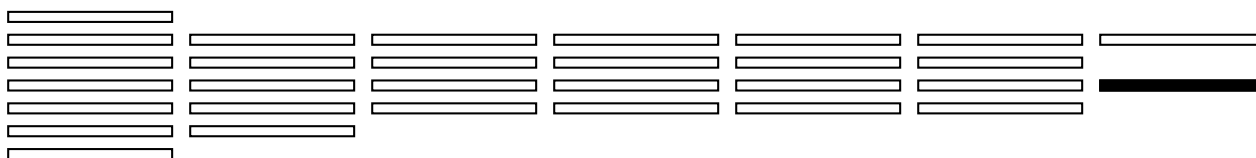

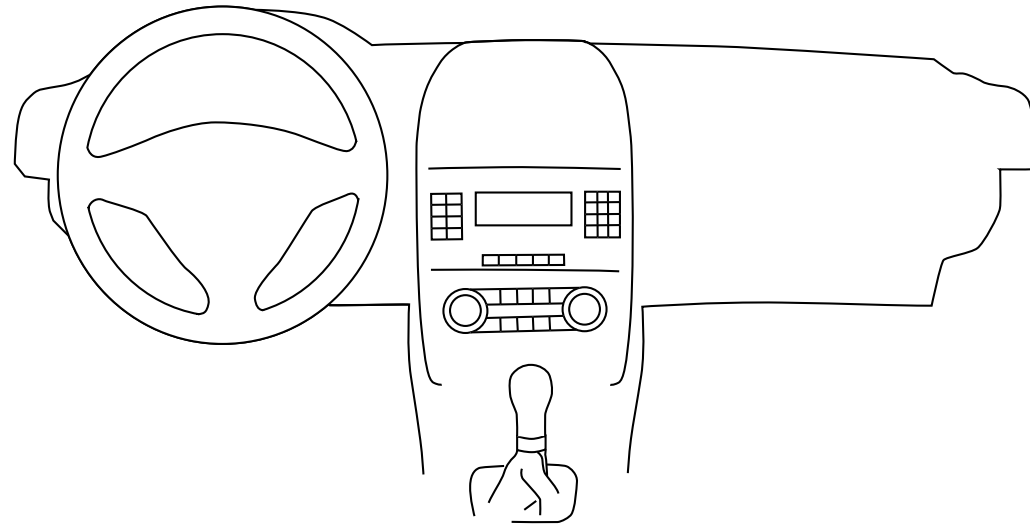

hapTECH 11/2009

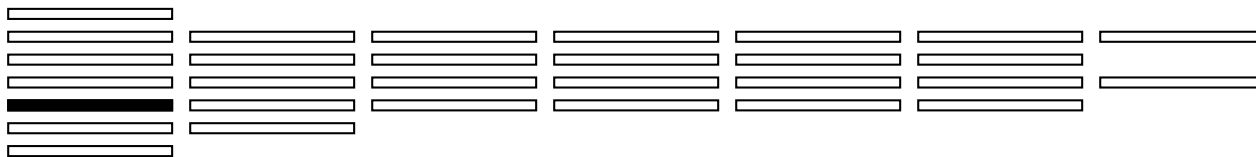



hapTECH 11/2009

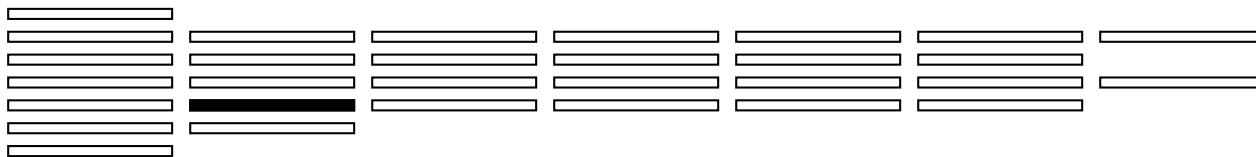

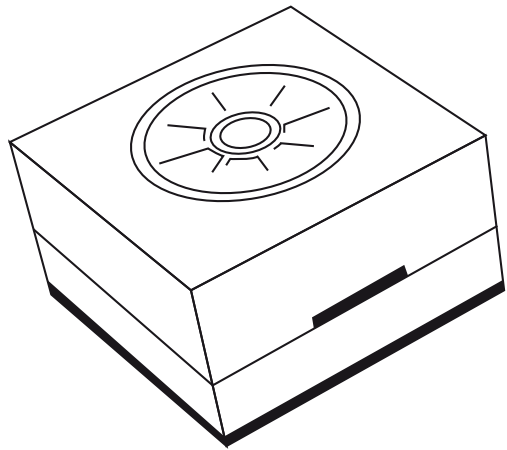

hapTECH 11/2009

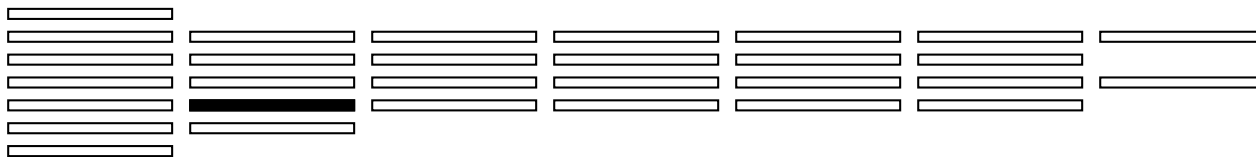

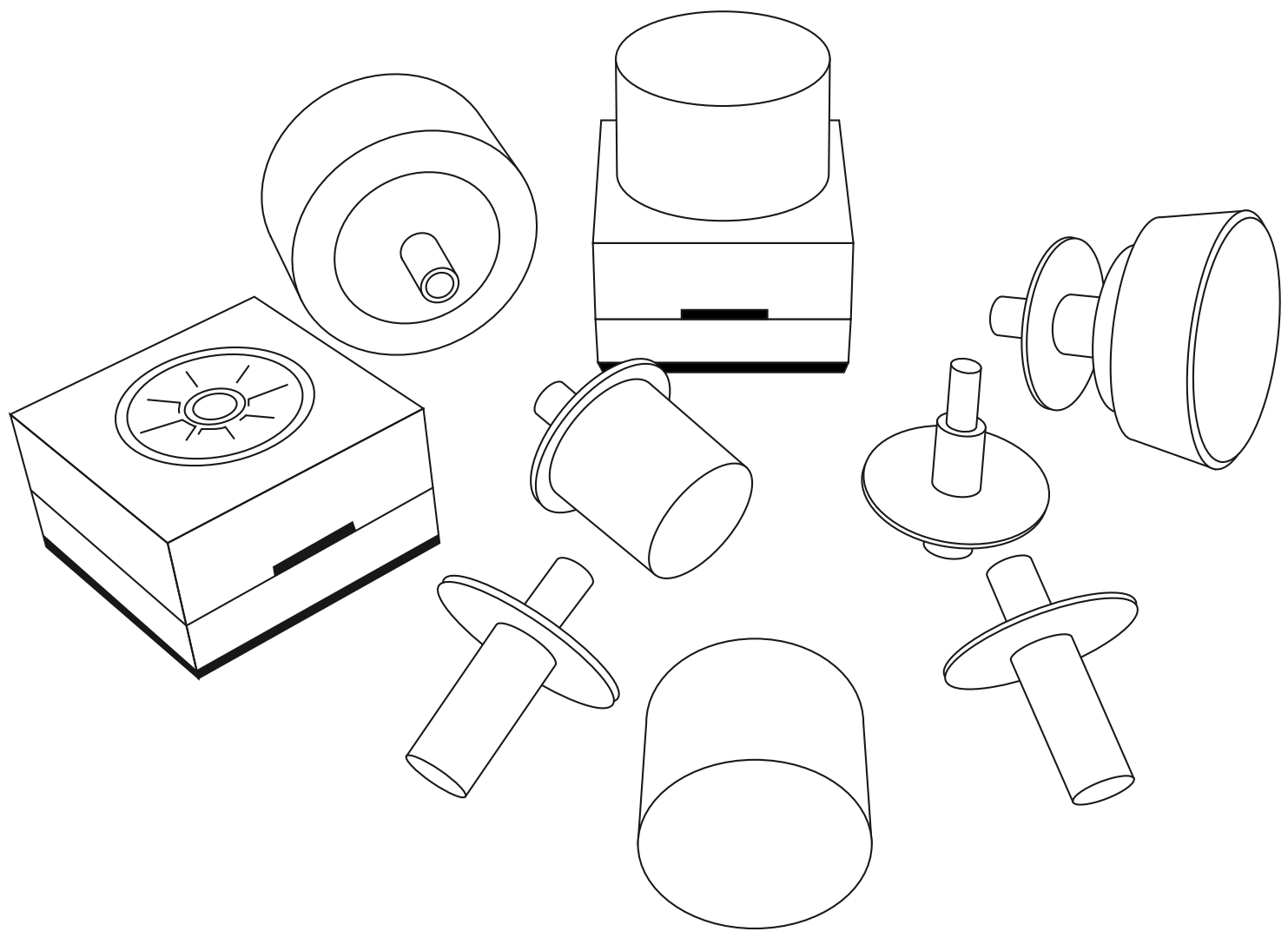

hapTECH 11/2009

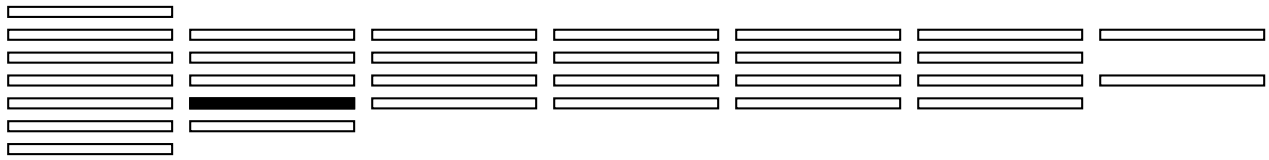

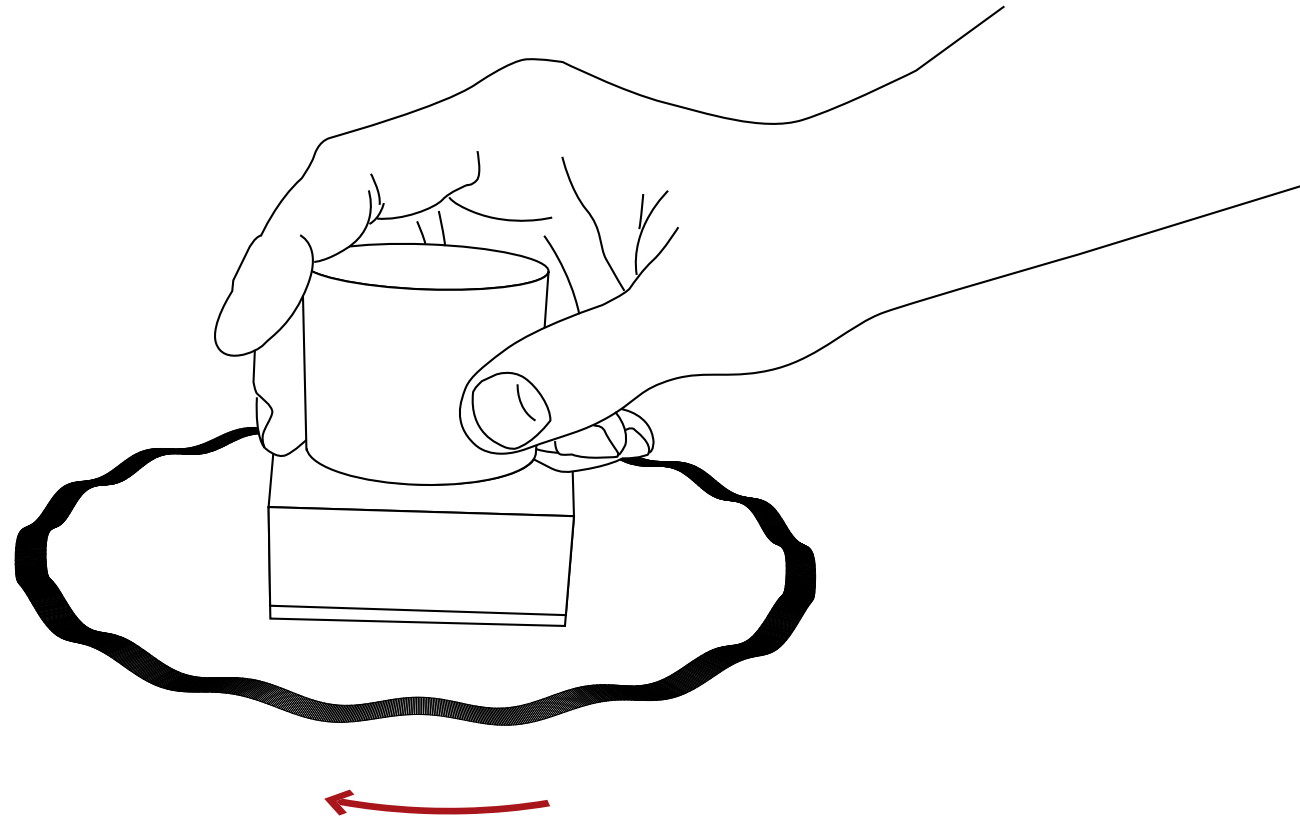

hapTECH 11/2009

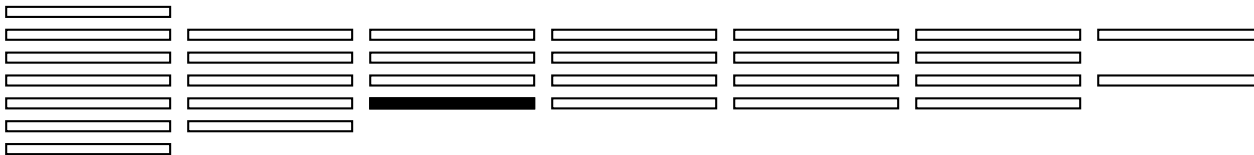

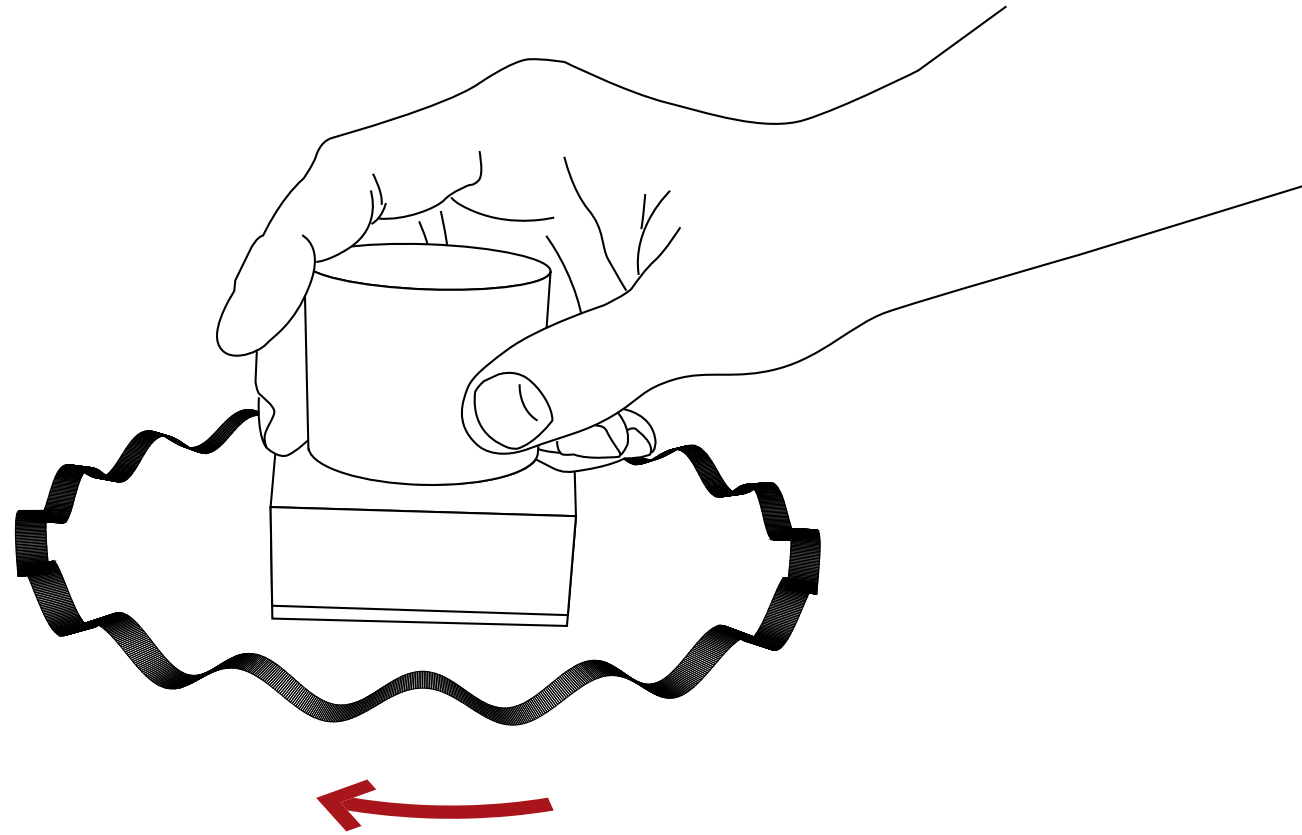

hapTECH 11/2009

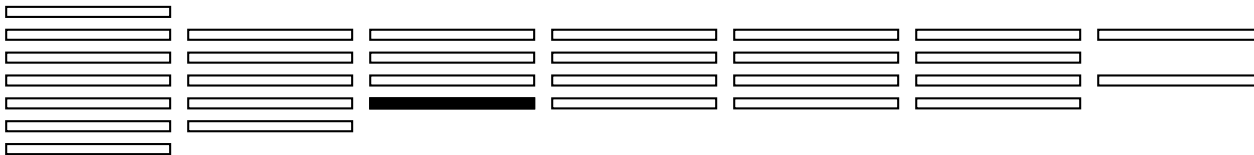

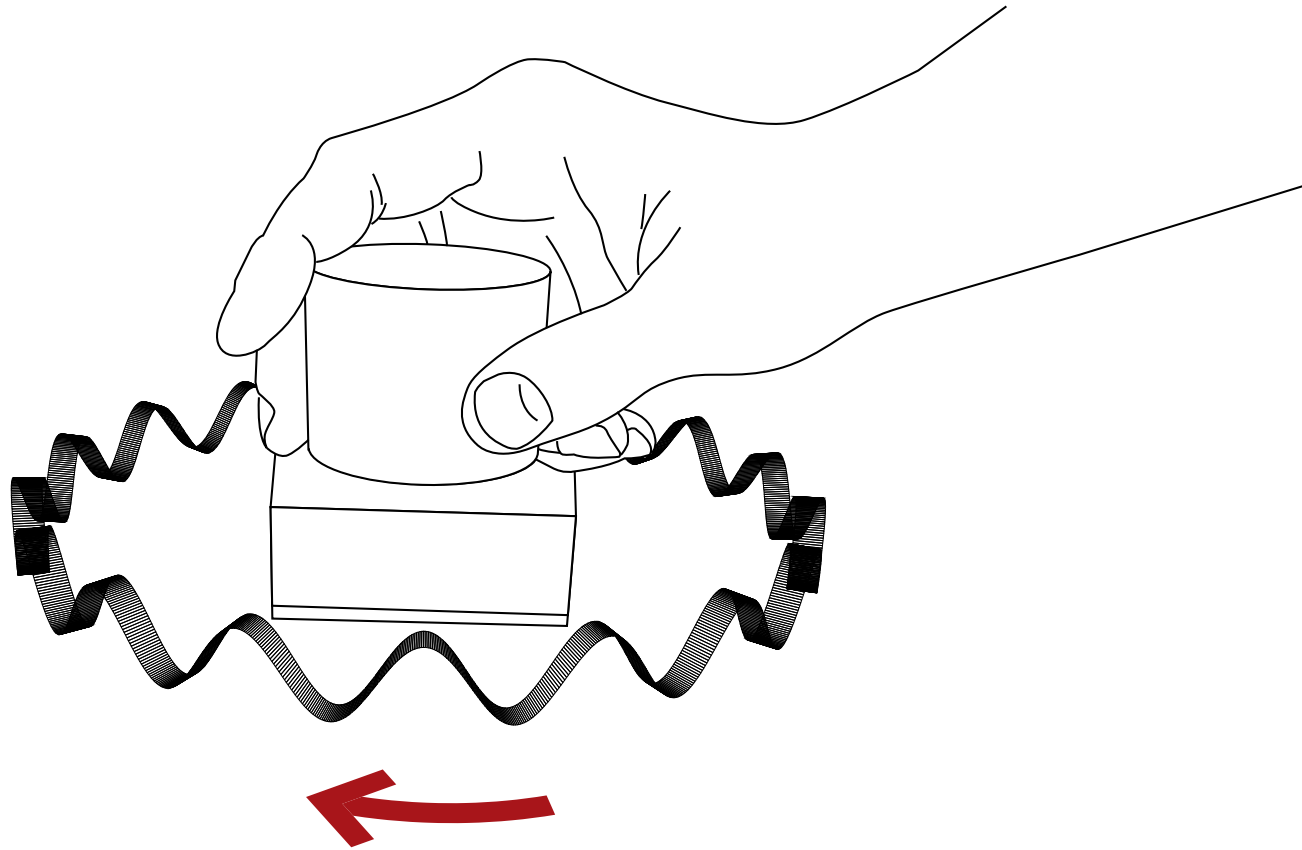

hapTECH 11/2009

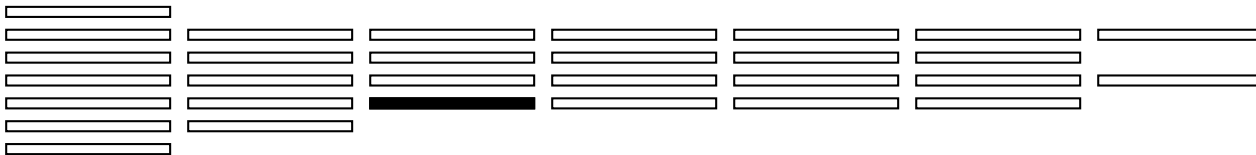

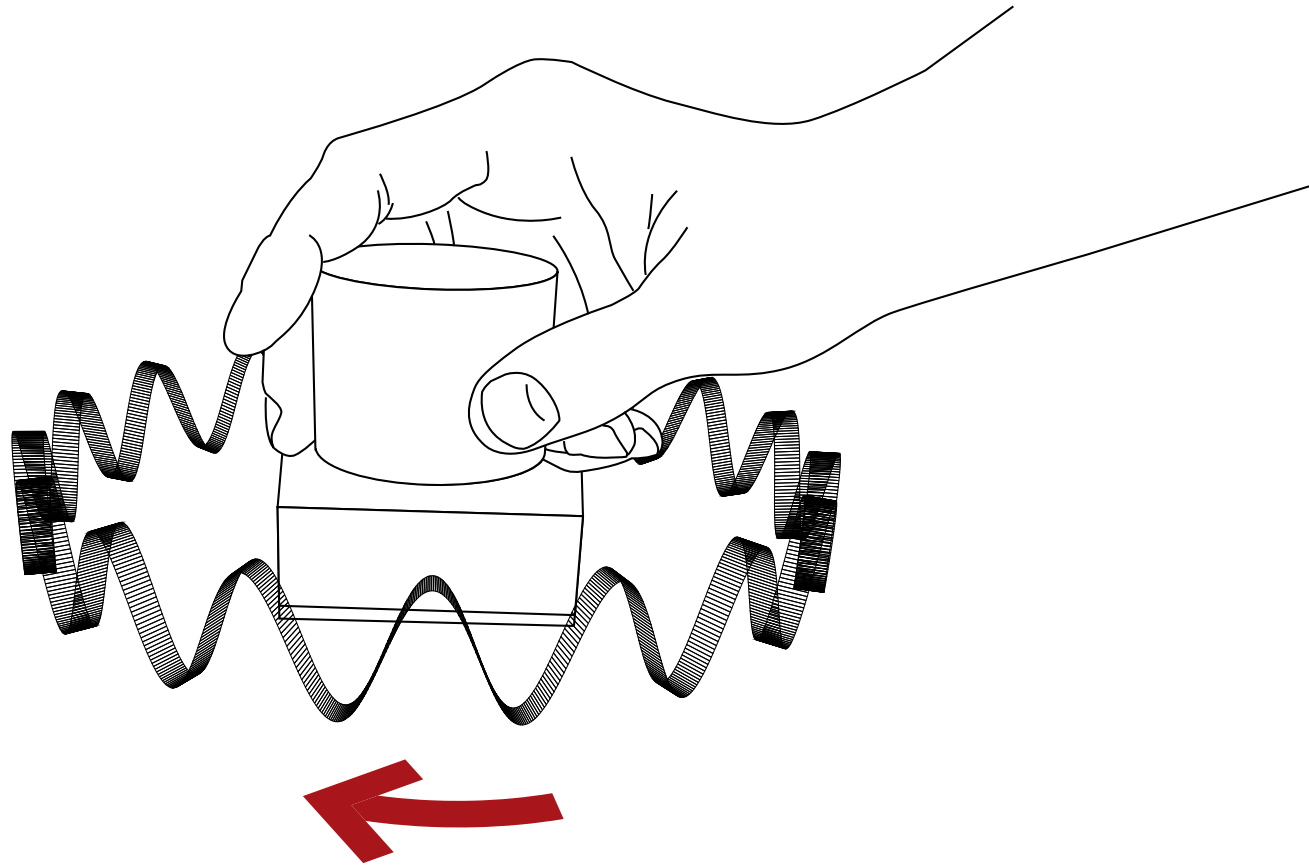

hapTECH 11/2009

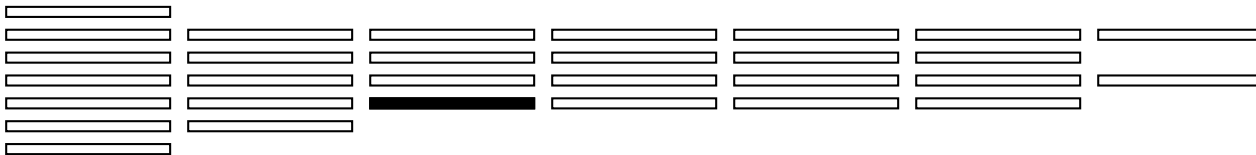

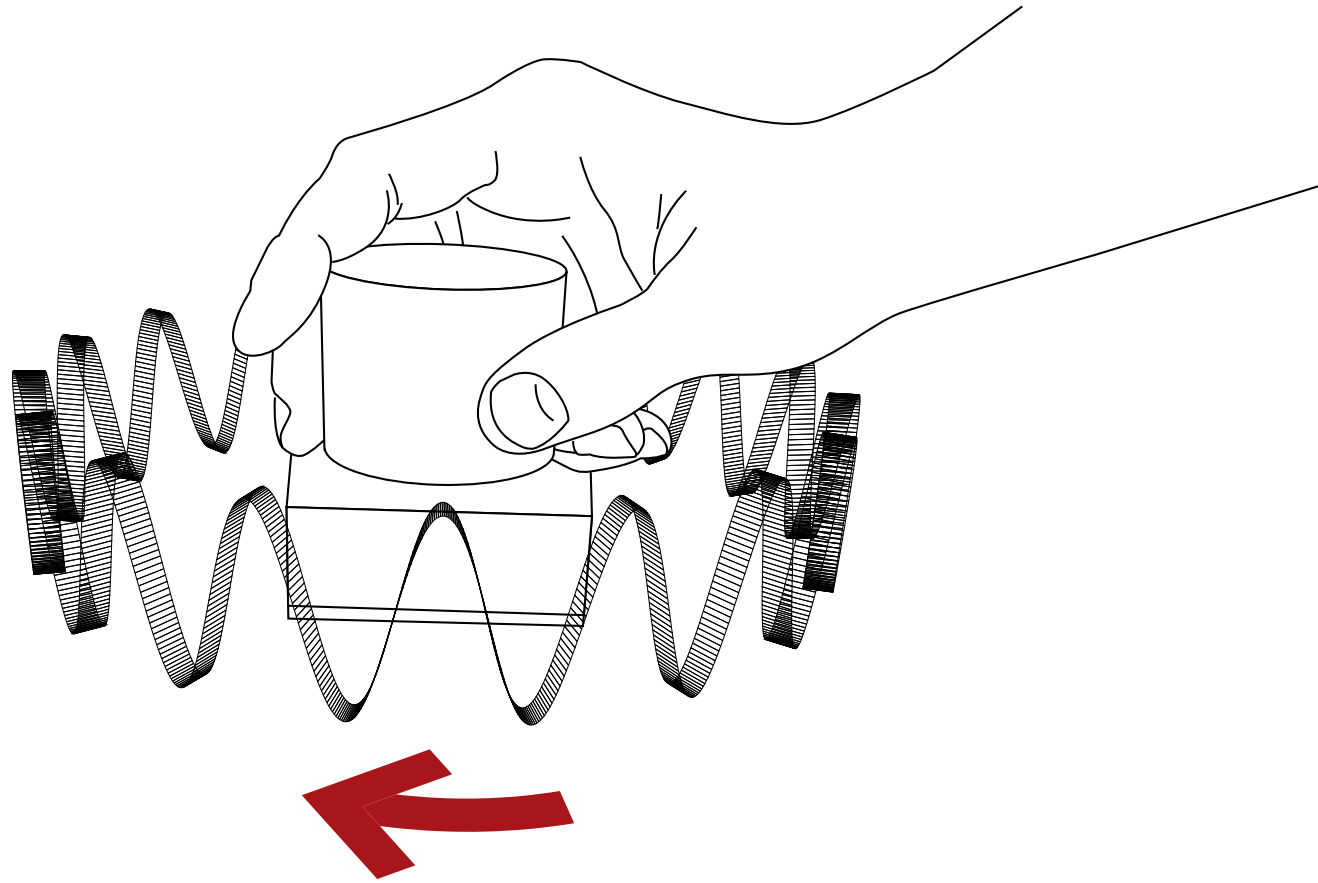

hapTECH 11/2009

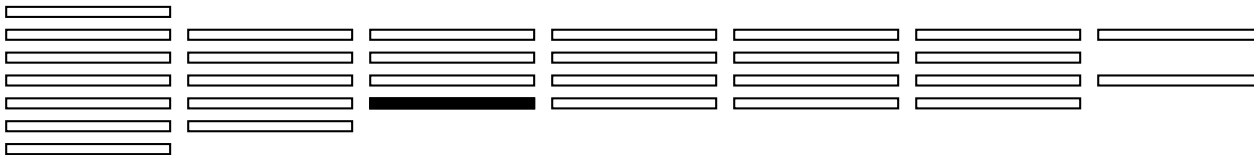

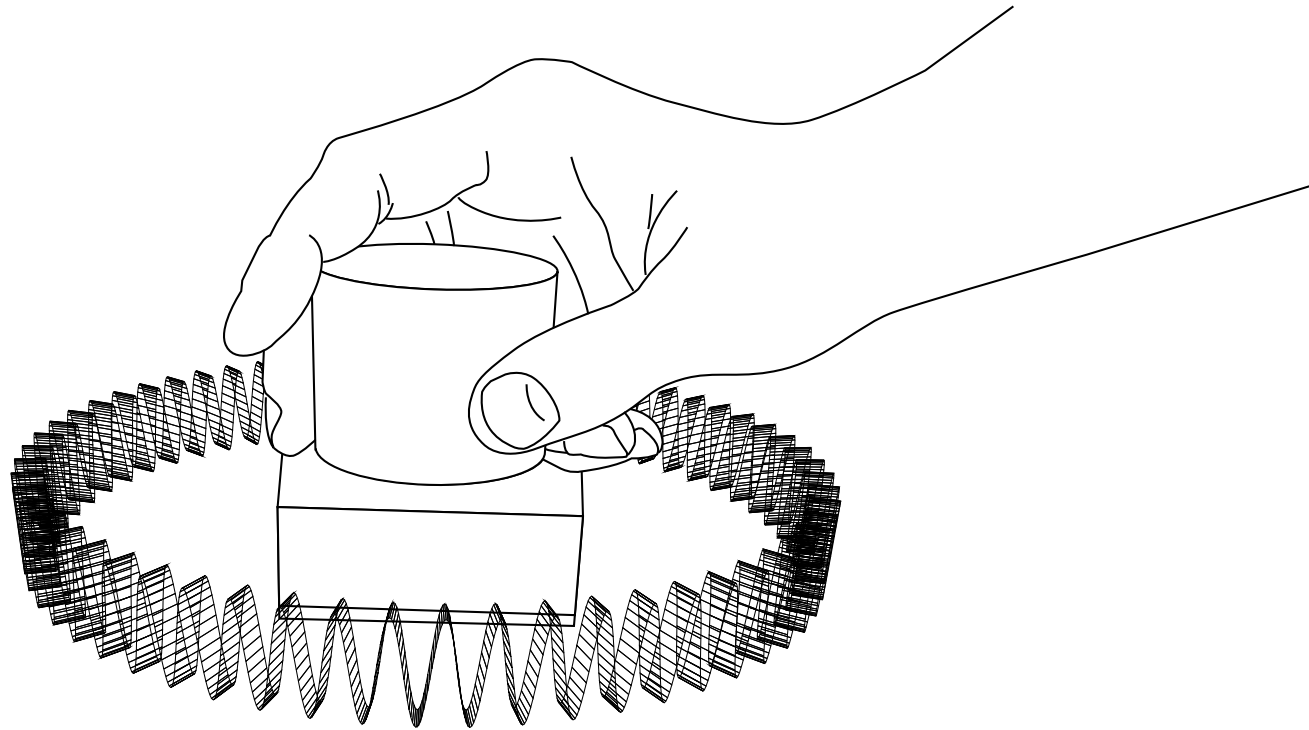

hapTECH 11/2009

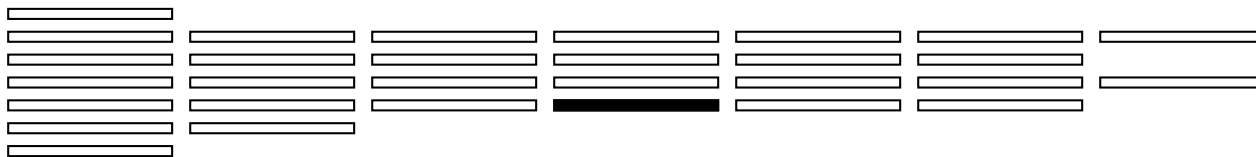

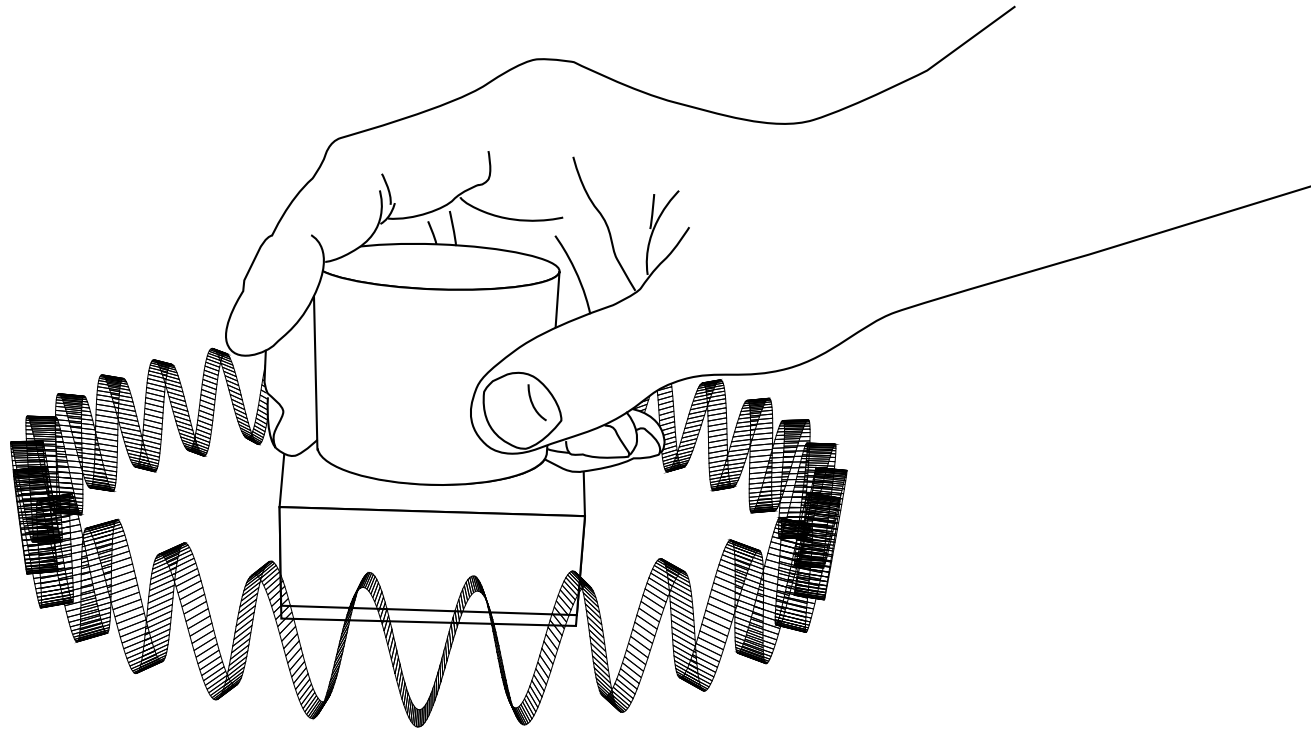

hapTECH 11/2009

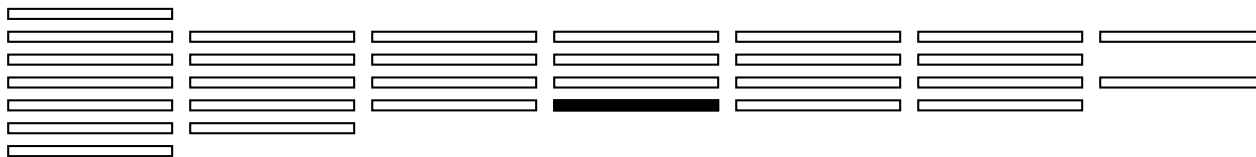

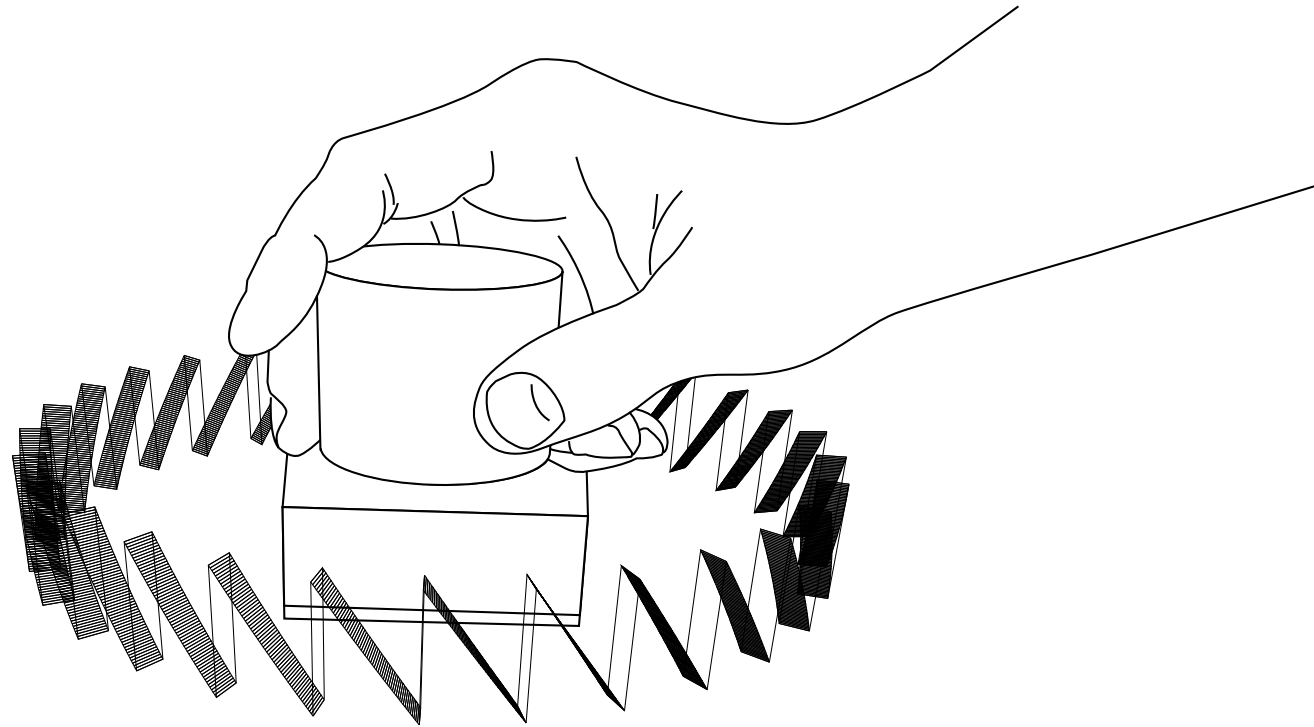

hapTECH 11/2009

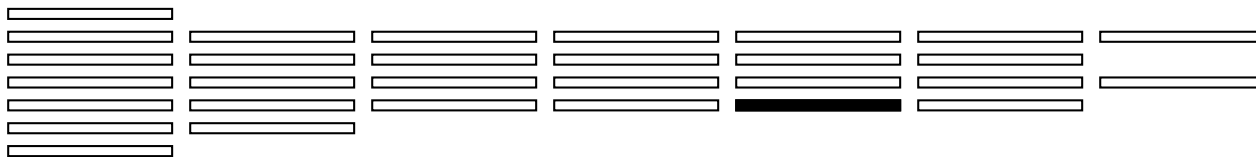

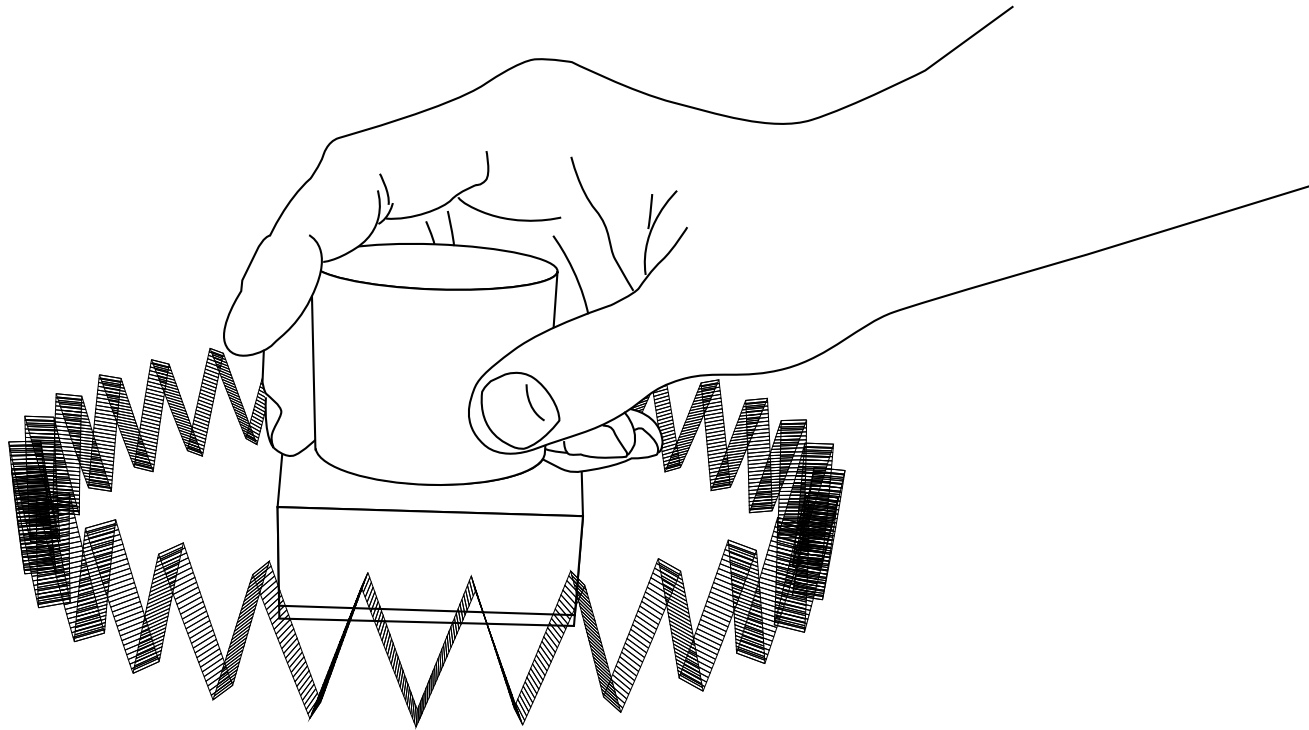

hapTECH 11/2009

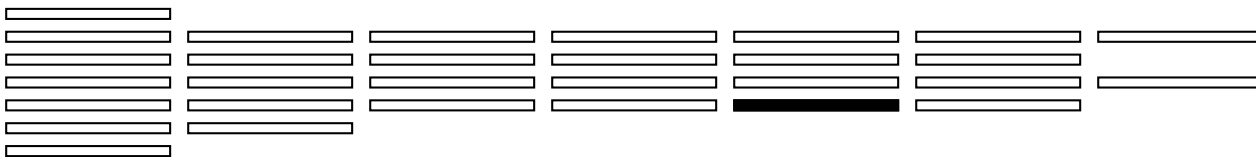



hapTECH 11/2009

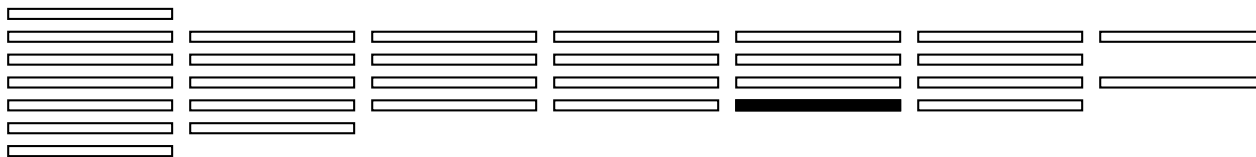

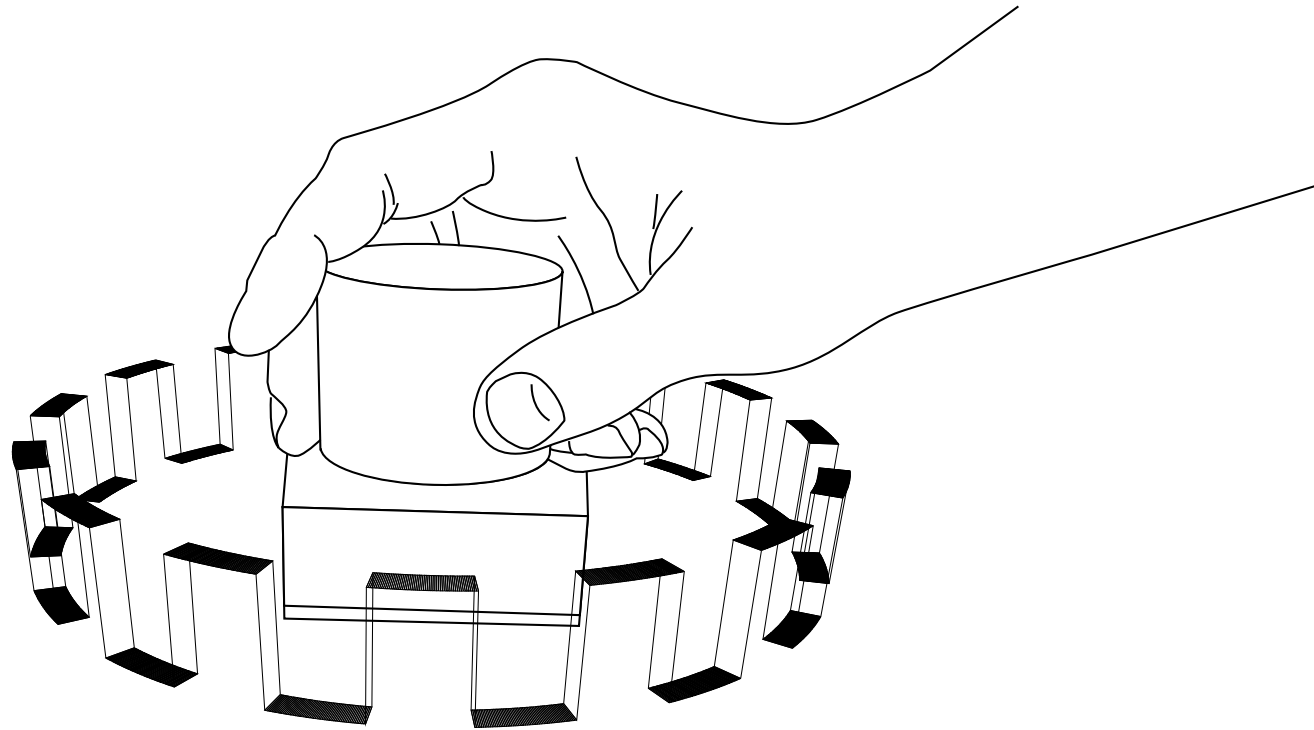

hapTECH 11/2009

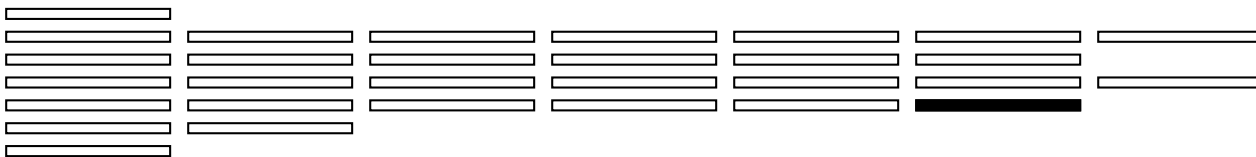

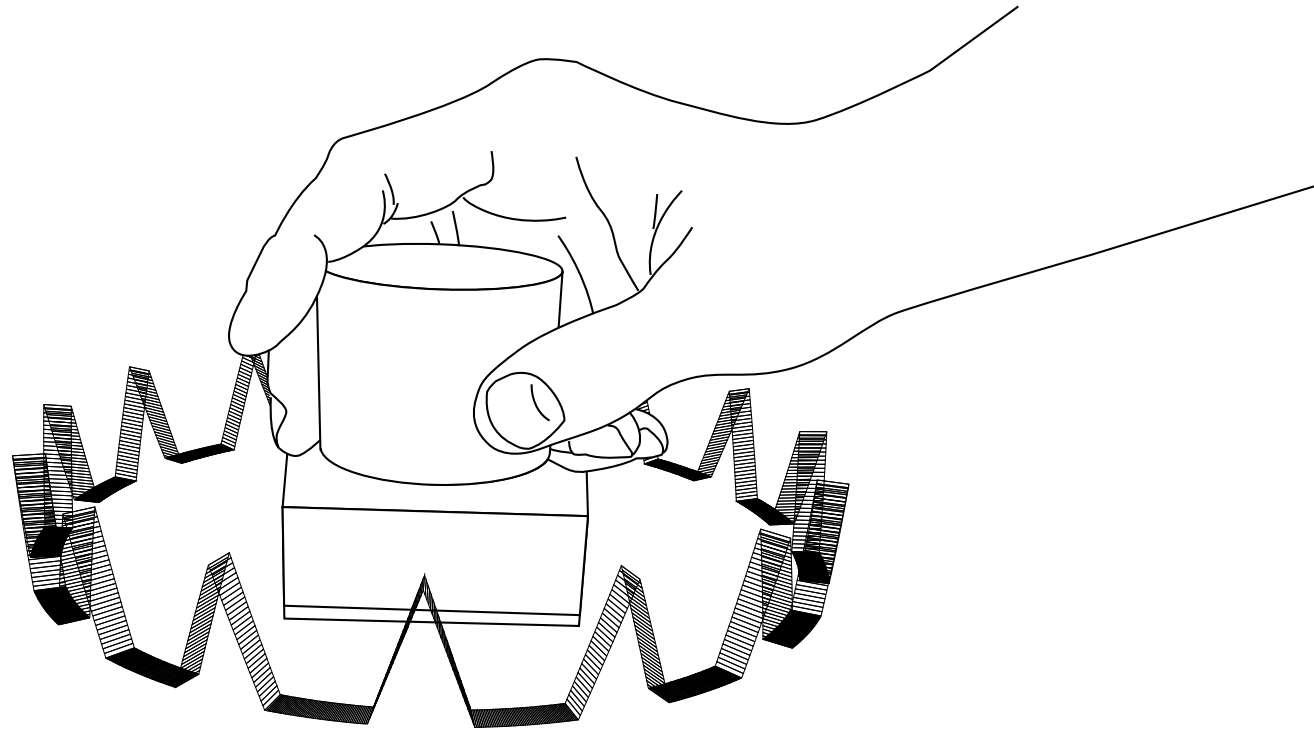

hapTECH 11/2009

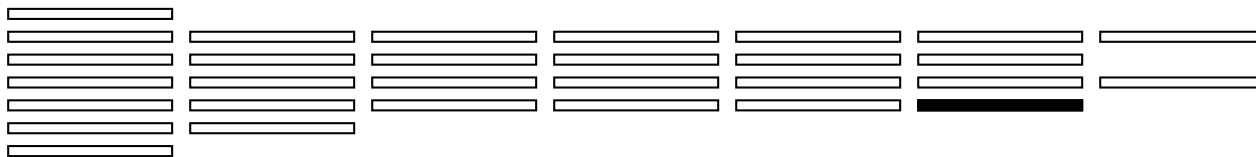

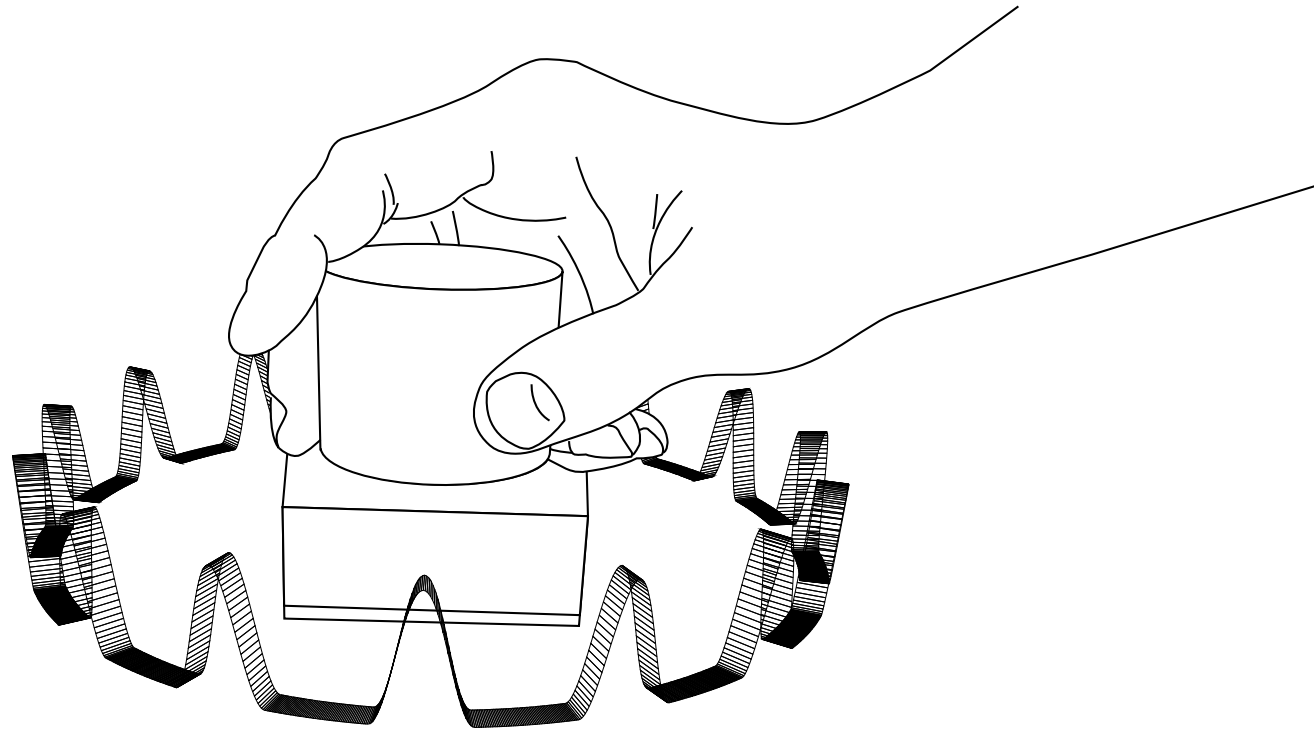

hapTECH 11/2009

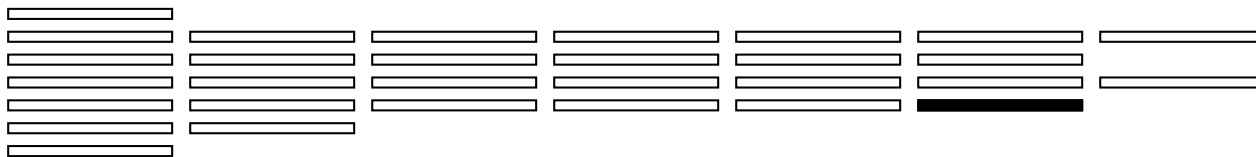

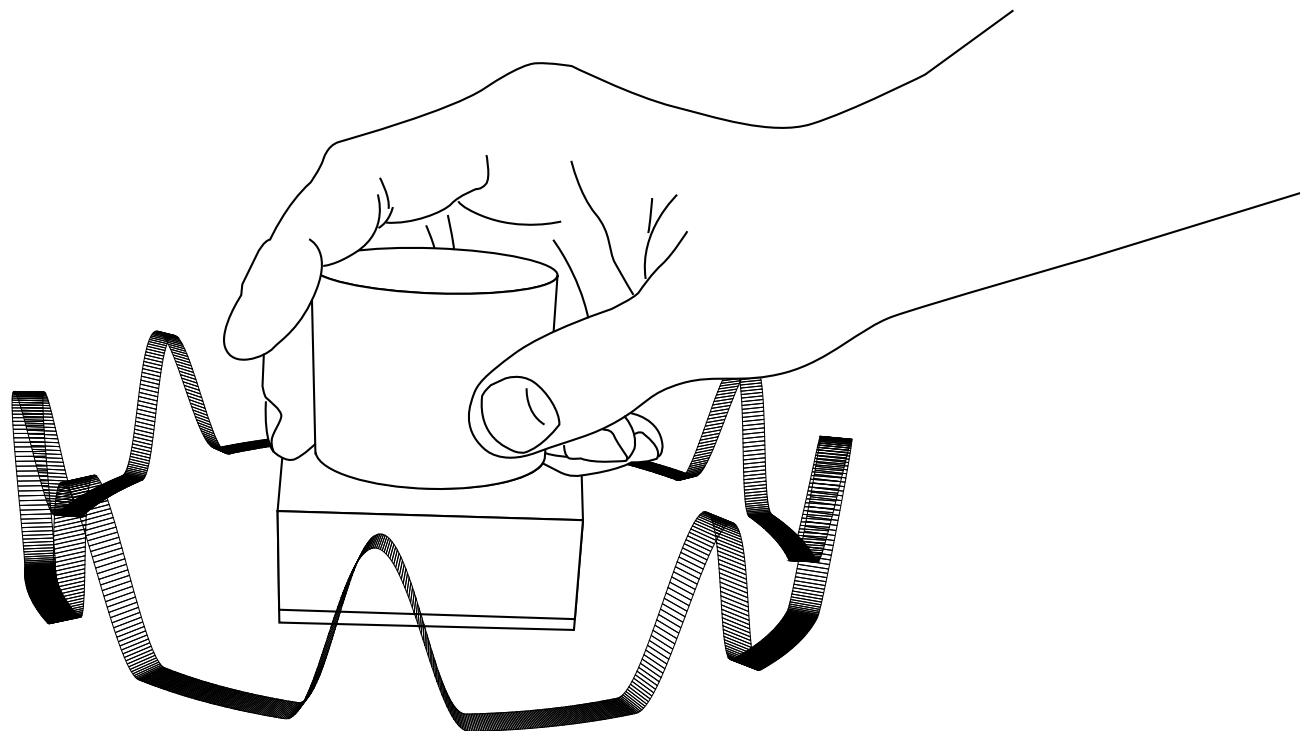

hapTECH 11/2009

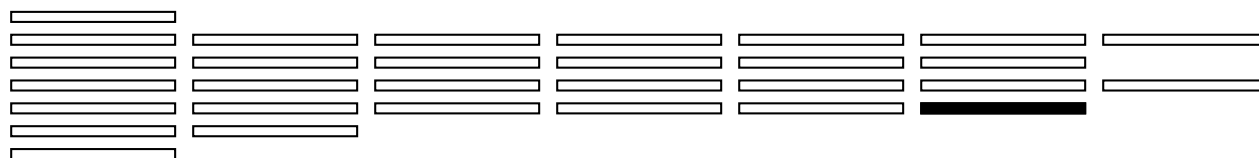



hapTECH 11/2009

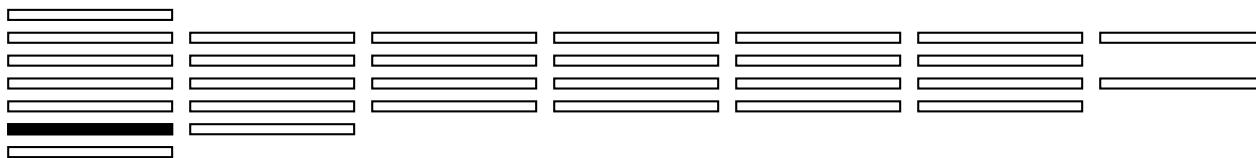

Temperatur Formbeständigkeit
 Steifheit Oberflächenmorphologie
 Flexibilität Durchdrückfestigkeit
 Elastizität Reibungswiderstand
 Festigkeit Schwingungsverhalten
 Fusseigenschaften Härte
 Rückprallelastizität Gewicht
 Masse Formgedächtnis
 Haftfestigkeit
 Struktur Abriebfestigkeit
 Textur Schlagzähigkeit
 Schlüpfrigkeit
 Brüchigkeit
 Dichte Druckfestigkeit
 Sprödigkeit
 Konsistenz
 Zähheit
 Gleitfähigkeit
 Schmierigkeit
 Klebrigkeit
 Porösität
 Nachgiebigkeit
 Dämpfung
 Rauheit

hapTECH 11/2009

